



Catalogo Generale

General Catalogue / Catalogue Général



Persiane blindate
Security shutters / Volets blindés

Cancelli di sicurezza
Security gates / Grilles de sécurité

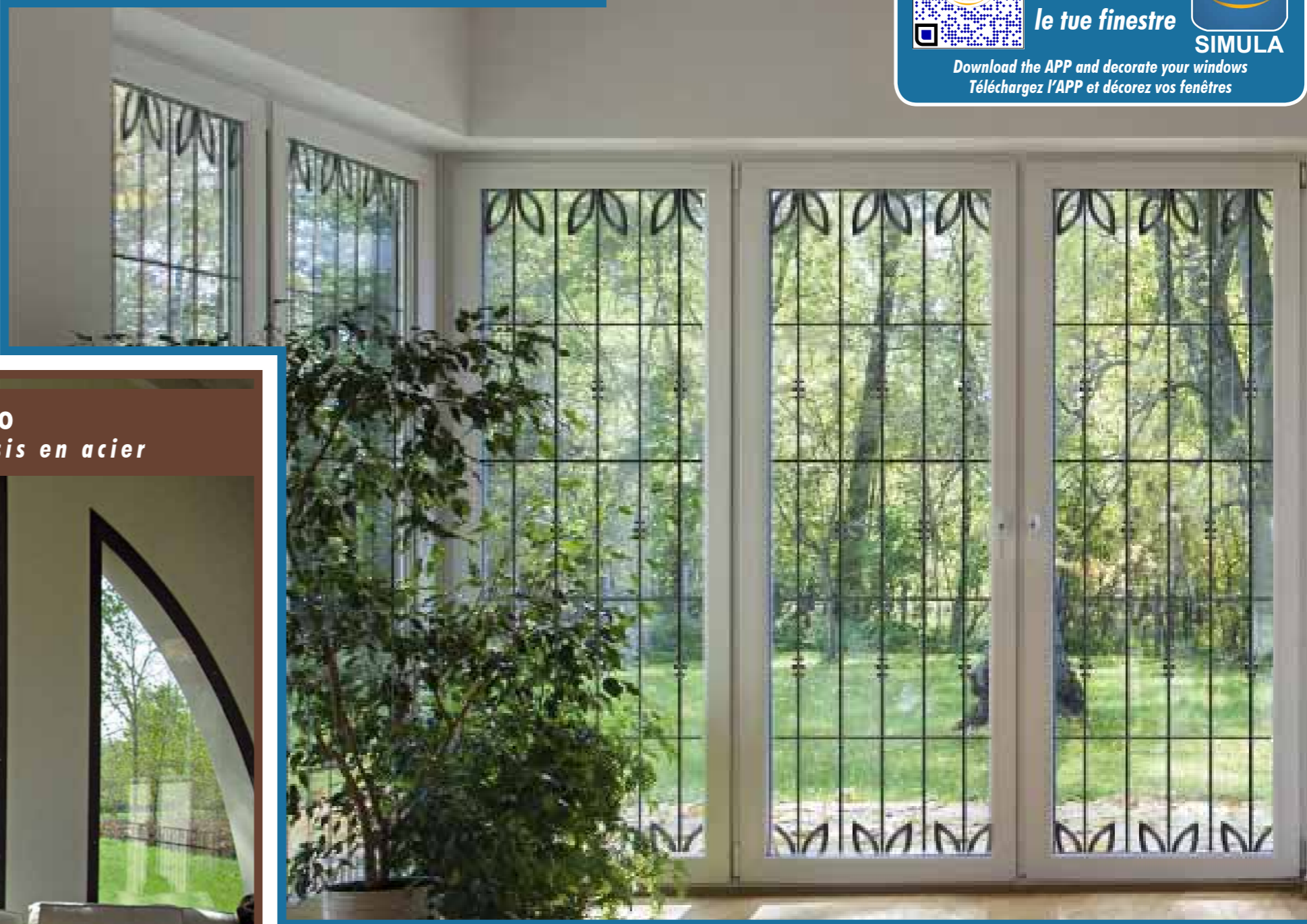

Scarica l'App
e arreda
le tue finestre



SIMULA

Download the APP and decorate your windows
Téléchargez l'APP et décorez vos fenêtres



Infissi in acciaio
Steel fixtures / Châssis en acier



Tre modi diversi per mettere in sicurezza la tua casa rispettando l'estetica e la praticità
Three different ways to secure your home while maintaining aesthetics and practicality
Trois façons différentes de sécuriser votre maison, tout en respectant l'esthétique et la commodité

Patent by New Art System













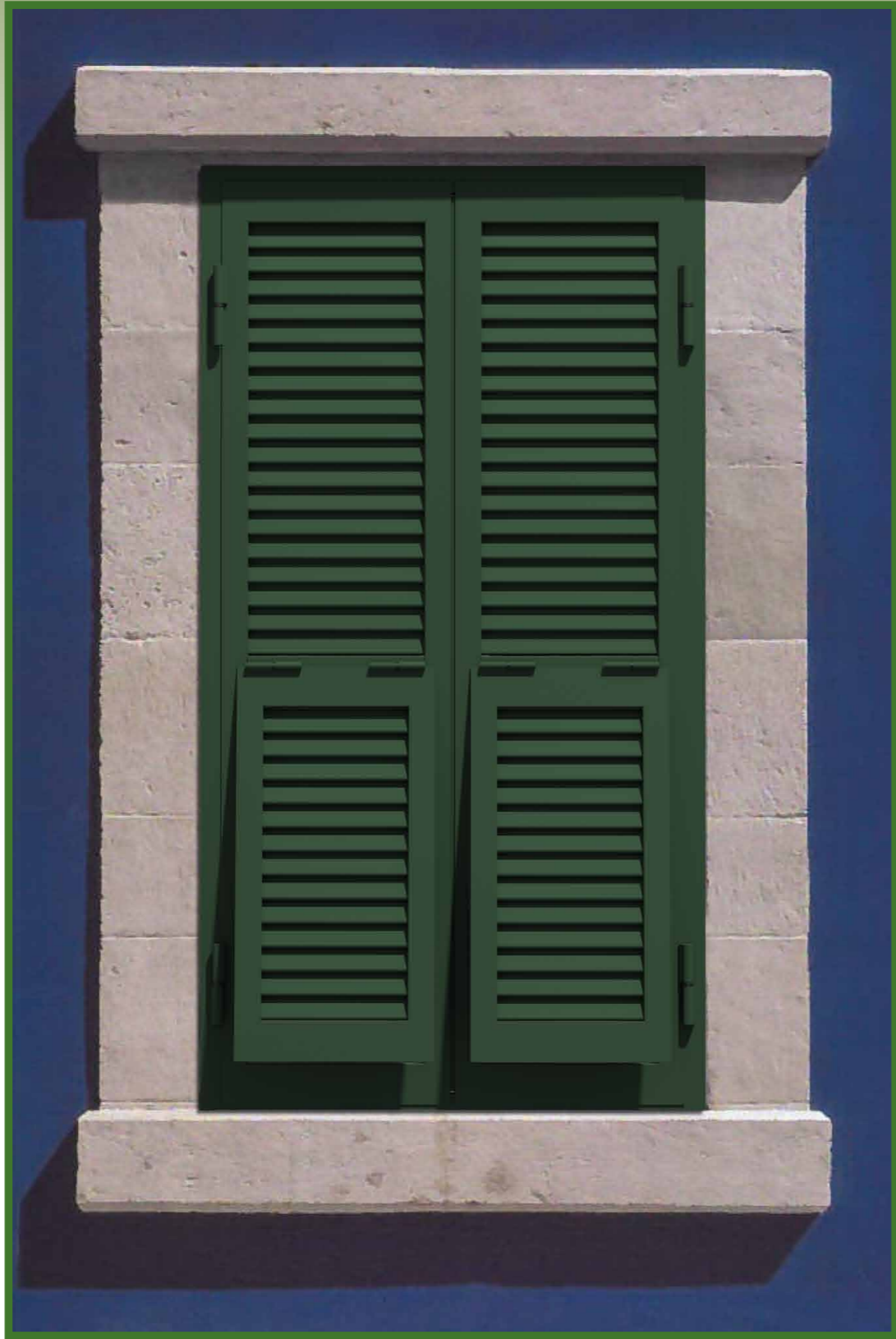













“ProArt significa personalizzazione di prodotti su misura, in aggiunta a qualità e precisione che solo con la tecnologia si può ottenere”

 ProArt a partire dalla sua fondazione nel 1994, con la creazione e il deposito del marchio Alladin®, ha trasformato la tradizionale costruzione manuale con profili commerciali dei prodotti, in vere e proprie linee di lavoro dedicate, che permettono di mantenere la personalizzazione dei prodotti realizzati, aggiungendo la qualità e la precisione ottenibili solamente utilizzando avanzate tecnologie lavorative.



“ProArt means product customization, with the quality and precision that only technology allows to obtain”

 Ever since its founding in 1994, with the creation and registration of the Alladin® Brand, ProArt has shifted the traditional way of building its products by hand to dedicated production lines, which allow to maintain full customization of all products and add in the quality and precision that only advanced processing technologies allow.



“ProArt est synonyme de produits personnalisés sur mesure, avec une qualité et précision qu’on ne peut obtenir qu’à l’aide de la technologie”

 ProArt depuis sa fondation en 1994, avec la création et l’inscription de la marque Alladin®, a transformé la construction manuelle traditionnelle avec des profils commerciaux des produits, en véritables lignes de travail dédiées, qui permettent de maintenir la personnalisation des produits réalisés, en ajoutant une qualité et précision qu’on ne peut obtenir qu’à l’aide de technologies d’élaboration avancées.

“I cancelli di sicurezza, le persiane blindate e gli infissi in acciaio Alladin® sono da 30 anni il Made in Italy d’eccellenza”

 La meccanica dei cancelli di sicurezza, persiane blindate ed infissi in acciaio Alladin®, è un brevetto europeo unico, che risolve con ante intere (non spezzate con gli snodi) qualsiasi problema di installazione lasciandovi grande praticità di movimentazione senza rinunciare all’estetica.

LA PROGETTAZIONE

Come nasce un’idea e si trasforma in design

Il reparto progettazione sviluppa brevetti esclusivi nel suo settore, curando nel dettaglio la sicurezza senza trascurare l’aspetto estetico. Questo fa sì che ogni manufatto Alladin® venga realizzato come un abito su misura per la vostra casa.



“Alladin® security gates, security shutters and steel fixtures have been an example of Made in Italy excellence for 30 years”

 The workings of Alladin® security gates, security shutters and steel fixtures are covered by a unique European Patent, and solve all installation problems with full (uninterrupted by hinges) shutters which leave unimpeded movement and practicality without giving up on aesthetics.

DESIGN

How ideas are born and evolve into design

Our design department develops exclusive patents in our field, ensuring security in all details without overlooking aesthetical issues. This means that every Alladin® product is like a bespoke suit for your home.



“Depuis 30 ans, les grilles de sécurité, les volets blindés et les châssis en acier Alladin® représentent le Made in Italy d’excellence”

 La mécanique des grilles de sécurité, des volets blindés, des châssis en acier Alladin® est un brevet européen unique qui, avec des battants entiers (pas fragmentés avec des charnières) résout tout problème d’installation, en vous permettant une grande maniabilité sans renoncer à l’esthétique.

LA PLANIFICATION

Comment une idée naît et se transforme en design

Le département de planification développe des brevets exclusifs dans son secteur, en s’occupant minutieusement de la sécurité sans négliger l’apparence esthétique. Chaque produit manufacturé Alladin® est donc réalisé comme s’il était un vêtement sur mesure pour votre maison.

 **LA BOBINA**

La qualità Alladin® parte dall'acciaio

ProArt crea i suoi prodotti partendo dal nastro in acciaio, immagazzinando scorte biennali che le permettono di fissare prezzi più competitivi senza renderli soggetti alle oscillazioni del mercato.



 **LA BOBINE**

La qualité Alladin® commence avec l'acier

ProArt réalise ses produits à partir de la latte en acier, avec un stock pour une période de deux ans qui lui permet de fixer des prix encore plus compétitifs, sans que ceux-ci dépendent des oscillations du marché.

 **THE COIL**

Alladin® quality starts with steel

ProArt creates its products from scratch with steel ribbon of which we have a full two-year stock at all times: this allows us to negotiate better prices and be protected from market fluctuations.



 **LA PROFILATURA**
Il cuore di tutti i prodotti Alladin®

Avere un reparto di profilatura al suo interno, rende la ProArt unica sul mercato. Il poter realizzare profili saldati e sagomati, creati in base alle necessità, è un'evoluzione rispetto ai vecchi concetti di assemblaggio basati su prodotti commerciali adattati per l'occasione, come avviene nelle officine standard.

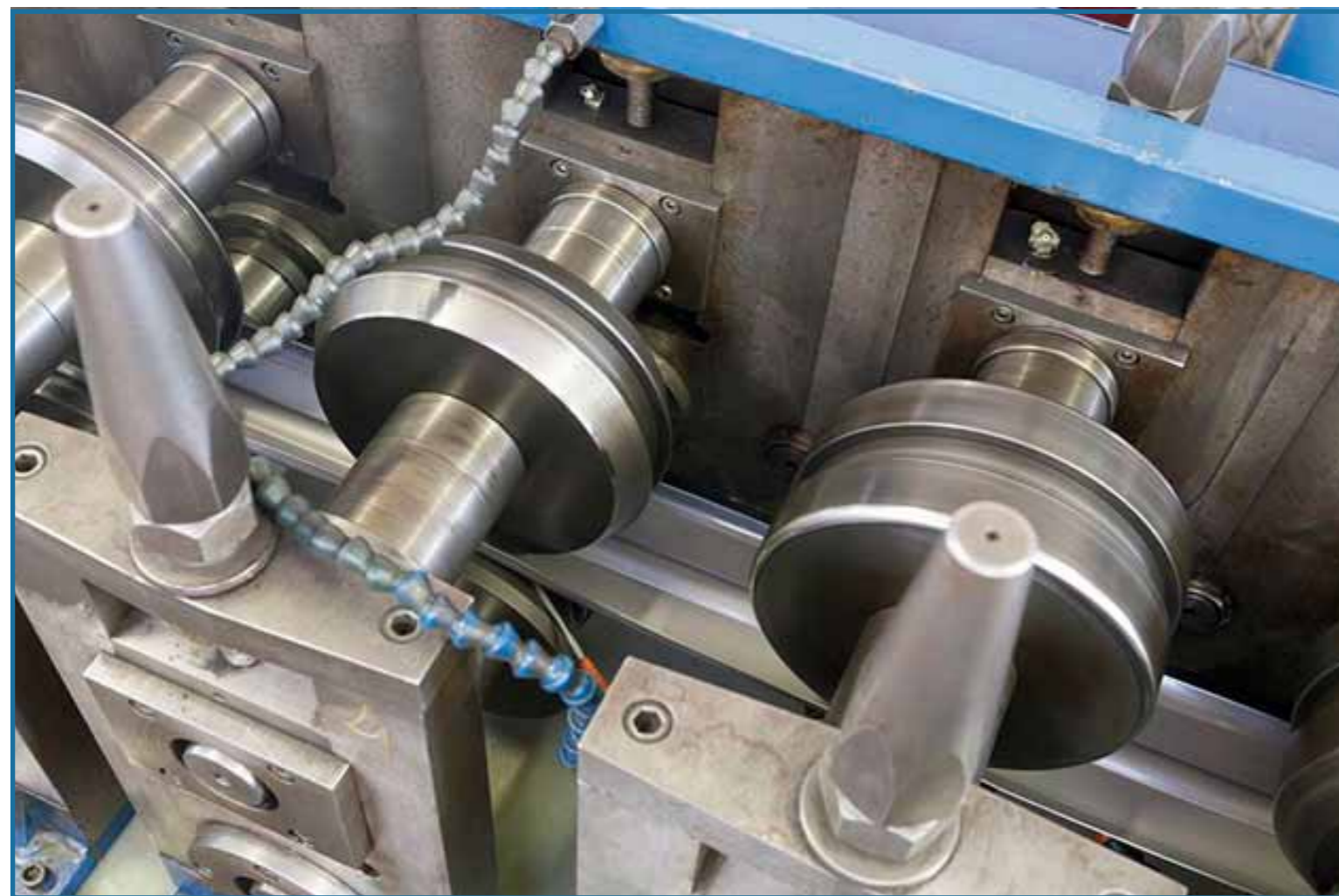

 **LE PROFILAGE**
Le cœur de tous produits Alladin®

Avec son département de profilage interne, ProArt est unique dans le marché. La possibilité de réaliser des silhouettes soudées et profilées, recréées selon les besoins, est une évolution par rapport aux vieux concepts d'assemblage s'appuyant sur produits commerciaux aptes pour une occasion, comme se produit dans les usines standards.

 **PROFILING**
The heart of all Alladin® products

Having our own internal profiling shop makes PRO ART unique in our market. The ability to manufacture welded, shaped profiles as necessity requires is a massive evolution when compared to the old assembly methods used in standard shops, based on adapting commercially available products on a case-by-case basis.



 **L'ASSEMBLAGGIO**

L'evoluzione della meccanica al servizio della sicurezza

Nel reparto robotizzato di ProArt il livello di tecnologia raggiunto perfeziona i prodotti nei minimi dettagli. Il processo di assemblaggio robotico consente di azzerare gli errori di misura, garantisce una perfetta saldatura e permette una realizzazione al millimetro di ante e telai.

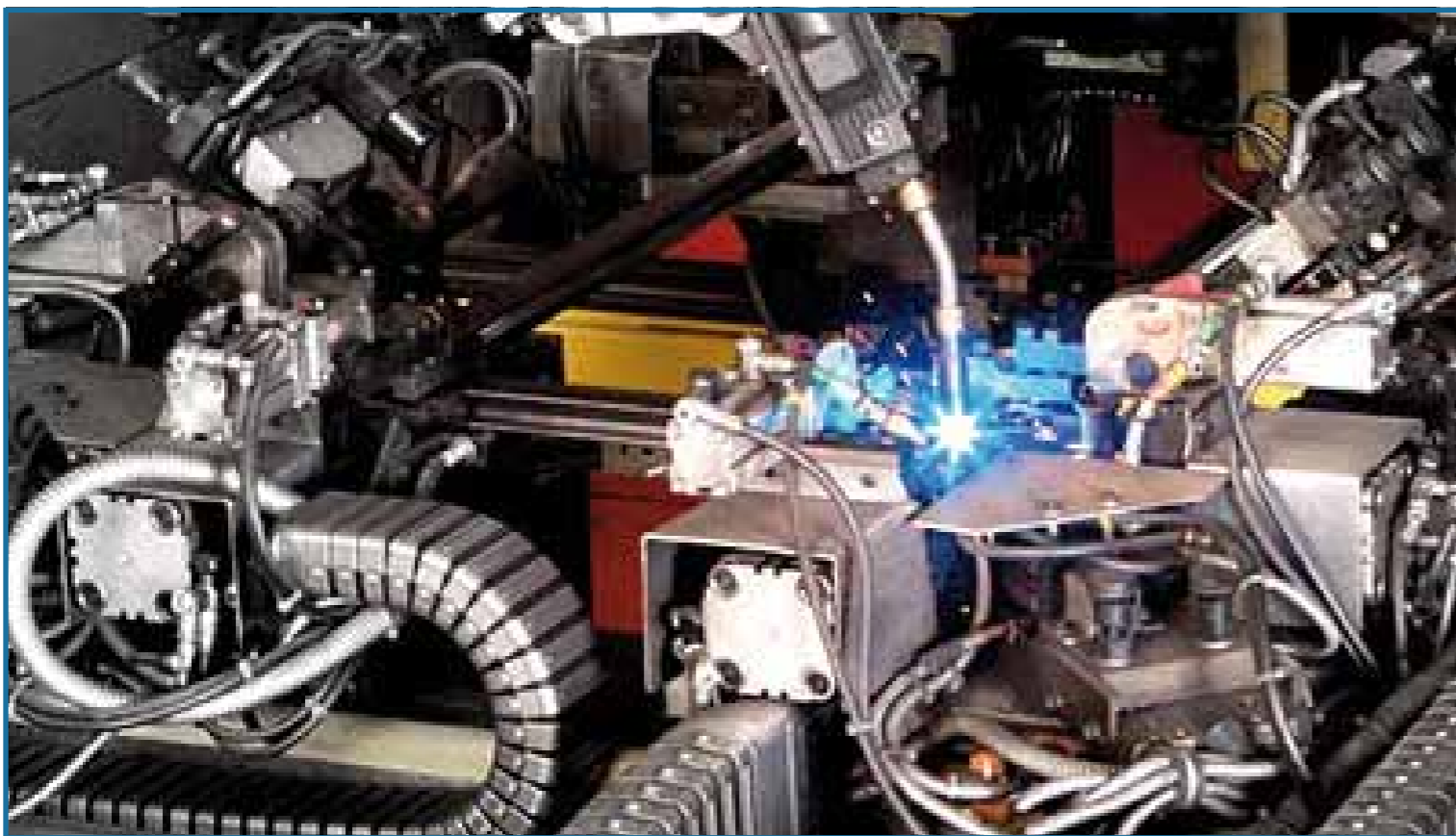

 **ASSEMBLY**

Mechanical evolution at the service of security

In ProArt's robotized shop, products are perfected to the slightest details through technology. Our robotized assembly process for window bars and security gates allows for elimination of measurement errors, guarantees perfect welding, and ensures a perfectly precise assembly of shutters and fixtures.

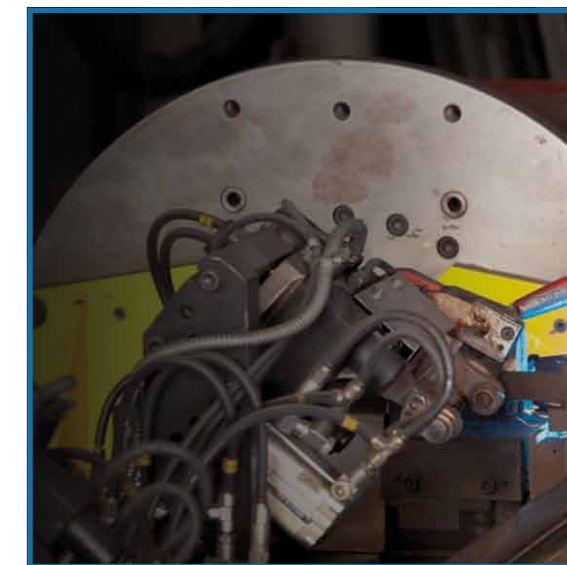
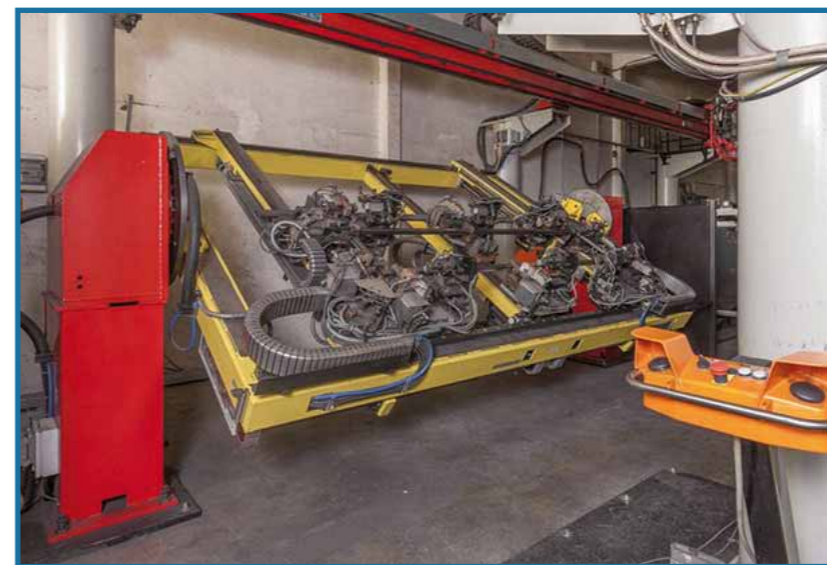

 **L'ASSEMBLAGE**

L'évolution de la mécanique au service de la sécurité

Dans le département robotisé ProArt, le niveau de technologie obtenu perfectionne les produits dans les détails les plus menus. Le procès d'assemblage robotisé permet d'annuler les erreurs de mesure, assure une soudure parfaite et permet une réalisation des battants et des châssis au millimètre près.

LA PERSONALIZZAZIONE

Arredate le vostre finestre, Alladin® non vi limita!

Punto di forza di ProArt è la personalizzazione dei disegni inseriti nel cancello di sicurezza. A differenza di tutti i prodotti a snodo che spezzano le ante, i sistemi di apertura Alladin® permettono di inserire un'ampia gamma di disegni a catalogo nonché a campione assecondando la richiesta del cliente, a patto che rispettino le norme di sicurezza e rientrino nelle certificazioni conseguite dai prodotti Alladin®.

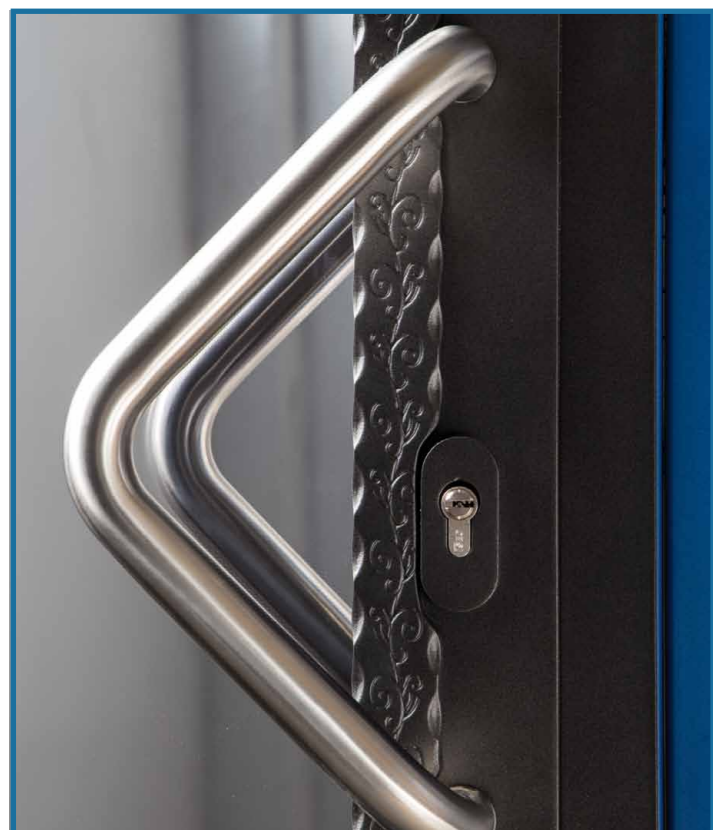

LA PERSONNALISATION

Équipez vos fenêtres, avec Alladin® il n'y a pas de limitations!

Point de force de ProArt est la personnalisation des dessins intégrés dans la grille de sécurité. Bien au contraire de tous les produits avec des jointures qui fragmentent les battants, avec les systèmes d'ouverture Alladin® on peut intégrer une ample gamme de dessins selon catalogue ou échantillon, suivant la requête du client, à condition qu'on respecte les normes de sécurité et qu'on reste dans la ligne des certifications obtenues par Alladin®.

PERSONALIZATION

Decorate your windows, Alladin® has no limits!

ProArt's strong point is the customization of any kind of design to be included in the security gate. Differently from all other similar products, which show breaks across the shutters, Alladin®'s opening systems allow for insertion of a wide range of decorative designs both in gates and window bars. Designs can be chosen from our vast catalogue, or made to the customer's requirements - as long as they respect safety norms and certifications obtained by Alladin® products.



LA VERNICIATURA

Un tocco finale per la durata nel tempo

Solo creando un impianto di verniciatura progettato esclusivamente per gli infissi di sicurezza è possibile avere un'altissima qualità della verniciatura stessa. L'impianto realizzato dalla ProArt prevede sei cicli di lavaggio e sgrassaggio, oltre all'applicazione sui manufatti delle nano tecnologie. Quest'ultima è un'applicazione chimica di ultimissima generazione che permette di conseguire la qualifica di mille ore anticorrosione nei test alle nebbie saline. Dopo questo trattamento vengono applicate due mani di verniciatura a polvere epossidica.



LE VERNISSAGE

Une touche finale pour la durée dans le temps

Seulement avec un équipement de vernissage dessiné exclusivement pour les châssis de sécurité il est possible d'obtenir une très haute qualité du vernissage même. L'équipement réalisé par ProArt prévoit six cycles de lavage et dégraissage, en plus de l'application des nanotechnologies aux produits manufacturés. Cette-ci est une application chimique de dernière génération, qui permet de parvenir à la qualification de milles heures de résistance contre la corrosion dans l'essai au brouillard salin. Après ce traitement, on applique deux couches de vernissage à poudre époxydique.

PAINTING

A final touch to guarantee durability

The only way to guarantee top quality painting is to establish a painting plant specifically designed for security fixtures. ProArt's automated painting line has six washing and degreasing stations, and also features the application of nanotechnologies to the products. This consists in a next-generation chemical application which has allowed our products to qualify for the 1000-hour in saline fog anti-corrosion test. This treatment is followed by the application of two hands of epoxy powder paint.



OLIVARI s.p.a. con Sede Unica
 Via Spiga 7
 20121 Caruggi - Milano - Italy
 Tel. +39 02 581 40288
 Fax +39 02 581 40288
 E-mail: info@olivari.net
 www.olivari.net
 C.A.P. 20138
 P. IVA 02766620151

1. Scopo della prova

Si vuole verificare:

- Prima compensa di macchie di corrosione sulla superficie dei campioni in corrispondenza dei punti di contatto e sovrapposizione di inserti e elementi decorativi in cui la protezione offerta dal film verniciato è scarsa o nulla.
- Resistenza del sistema metallo + trattamento + verniciatura all'esposizione in nebbia salina. La valutazione verrà effettuata su superfici piane correttamente verniciate.

4. Esecuzione della prova

La prova è stata eseguita secondo la norma UNI ISO 9227 del 2012 su:
 2 campioni in ferro saldato.
 Nella fattispecie i campioni sono riproduzioni di infestiate per esterni

Numero 2259 2260

Trattamento effettuato:

Campione 2273 Fosforgrassaggio acido FS 112A per 3 minuti
 Risciacquo con acqua di rete per 60 secondi
 Risciacquo con acqua di rete per 60 secondi
 Risciacquo con acqua demineralizzata per 60 secondi
 Conversione con Oliver 68 per 30 secondi
 Asciugatura
 Verniciati con fondo epossidico + poliestere a finire

Campione 2274 Fosforgrassaggio acido FS 112A per 3 minuti
 Risciacquo con acqua di rete per 60 secondi
 Risciacquo con acqua di rete per 60 secondi
 Risciacquo con acqua demineralizzata per 60 secondi
 Conversione con Oliver 68 per 30 secondi
 Asciugatura
 Verniciati con fondo epossidico + poliestere a finire

Mod. 5.10.12 Rev. 1 Ed. 02.02.2010
 Sede Legale Via General Gonne, 37 Milano - C.T.A. n. 041362509 - Imp. Reg. Sic. MI 3144370277
 Pagina 4 di 4

OLIVARI s.p.a. con Sede Unica
 Via Spiga 7
 20121 Caruggi - Milano - Italy
 Tel. +39 02 581 40288
 Fax +39 02 581 40288
 E-mail: info@olivari.net
 www.olivari.net
 C.A.P. 20138
 P. IVA 02766620151

5. Risultati della prova

I campioni sono stati posizionati in verticale appendendoli tramite filo non conduttore.

PROART	materiale	data	ore	EPOSSIDICA + POLIESTERE 2 STRATI	Numero identificativo e descrizione del trattamento	USCITA RUGGINE DA INSERITI	USCITA RUGGINE DA INSERITI	USCITA RUGGINE DA INSERITI	USCITA RUGGINE DA INSERITI
	25 nov 18			2273 A	2273 B	2274 A	2274 B		
	28/11/16	69		OK	OK	OK	OK	OK	OK
	30/11/16	114		OK	OK	OK	OK	OK	OK
	02/12/16	161		OK	OK	OK	OK	OK	OK
	05/12/16	231		OK	OK	OK	OK	OK	OK
	07/12/16	278		OK	OK	OK	OK	OK	OK
	14/12/16	326		OK	OK	OK	OK	OK	OK
	16/12/16	372		OK	OK	OK	OK	OK	OK
	19/12/16	443		OK	OK	OK	OK	OK	OK
	21/12/16	490		OK	OK	OK	OK	OK	OK
	23/12/16	536		OK	OK	OK	OK	OK	OK
	11/01/17	583		OK	OK	OK	OK	OK	OK
	13/01/17	629		OK	OK	OK	OK	OK	OK
	16/01/17	686		OK	OK	OK	OK	OK	OK
	18/01/16	745		OK	OK	OK	OK	OK	OK
	20/01/17	794		OK	OK	OK	OK	OK	OK
	23/01/17	865		OK	OK	OK	OK	OK	OK
	25/01/17	912		OK	OK	OK	OK	OK	OK
	27/01/17	960		OK	OK	OK	OK	OK	OK
	30/01/17	1031		OK	OK	OK	OK	OK	OK
	01/02/17	1078		TOLTO	TOLTO	TOLTO	TOLTO		

SPessori

2273 A	226 +/- 15,1
2273 B	192 +/- 8,3
2274 A	219 +/- 6,1
2274 B	223 +/- 10,5

Mod. 5.10.12 Rev. 1 Ed. 02.02.2010
 Sede Legale Via General Gonne, 37 Milano - C.T.A. n. 041362509 - Imp. Reg. Sic. MI 3144370277
 Pagina 4 di 4

 **IL CONTROLLO QUALITA'**

La regola d'arte non è un caso, Alladin® lo sa!

Ogni pezzo realizzato negli impianti della ProArt viene scrupolosamente controllato in fase di assemblaggio finale. Tutti i pezzi vengono accuratamente imballati e il prodotto è pronto per essere consegnato a casa vostra!

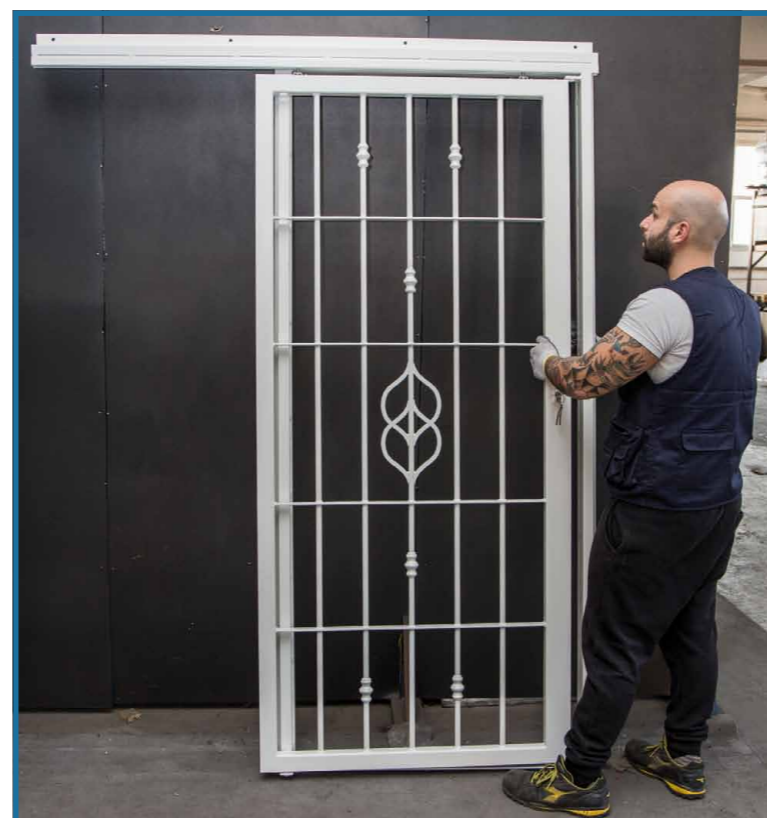
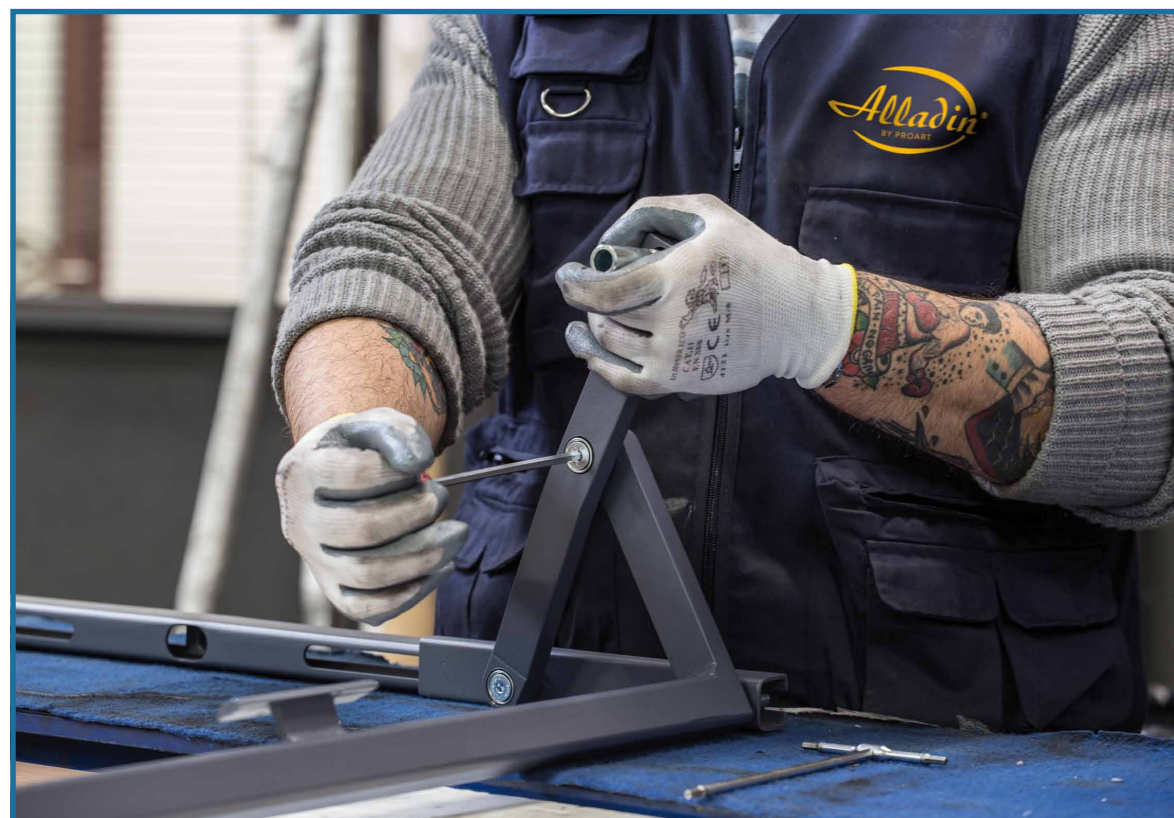

QUALITY CONTROL

Perfection doesn't happen by chance, Alladin® knows!

Each single piece manufactured in ProArt's shop is carefully checked during assembly. All parts are carefully packaged, and only then is the product ready to be delivered to your home!



 **CONTRÔLE DE LA QUALITÉ**

La règle d'art n'est pas une coïncidence, Alladin® le sait bien!

Chaque pièce réalisée dans les usines de ProArt est contrôlée minutieusement pendant la phase d'assemblage final. Toutes les pièces sont enveloppées soigneusement et le produit est prêt pour être livré chez vous!

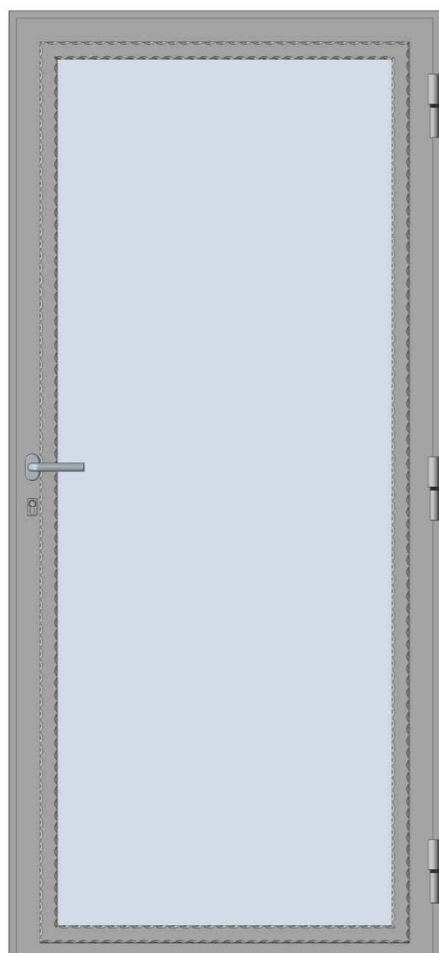

Porta con cornice martellata
Door with hammered frame
Porte avec cadre façonné au marteau

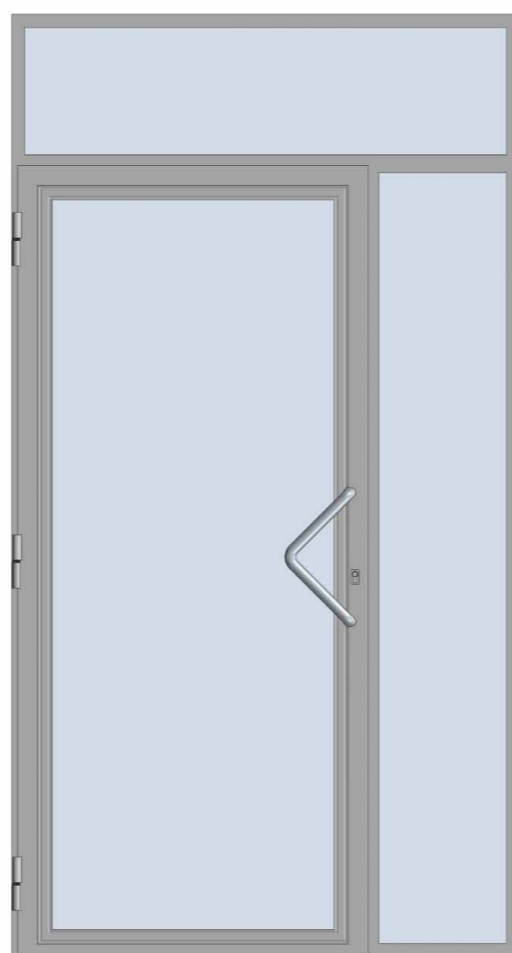

Portoncino con sopra e fianco luce fissi con cornice sagomata
Door with fixed top and side windows in moulded frames
Porte avec feu fixe supérieur et latéral et cadre profilé

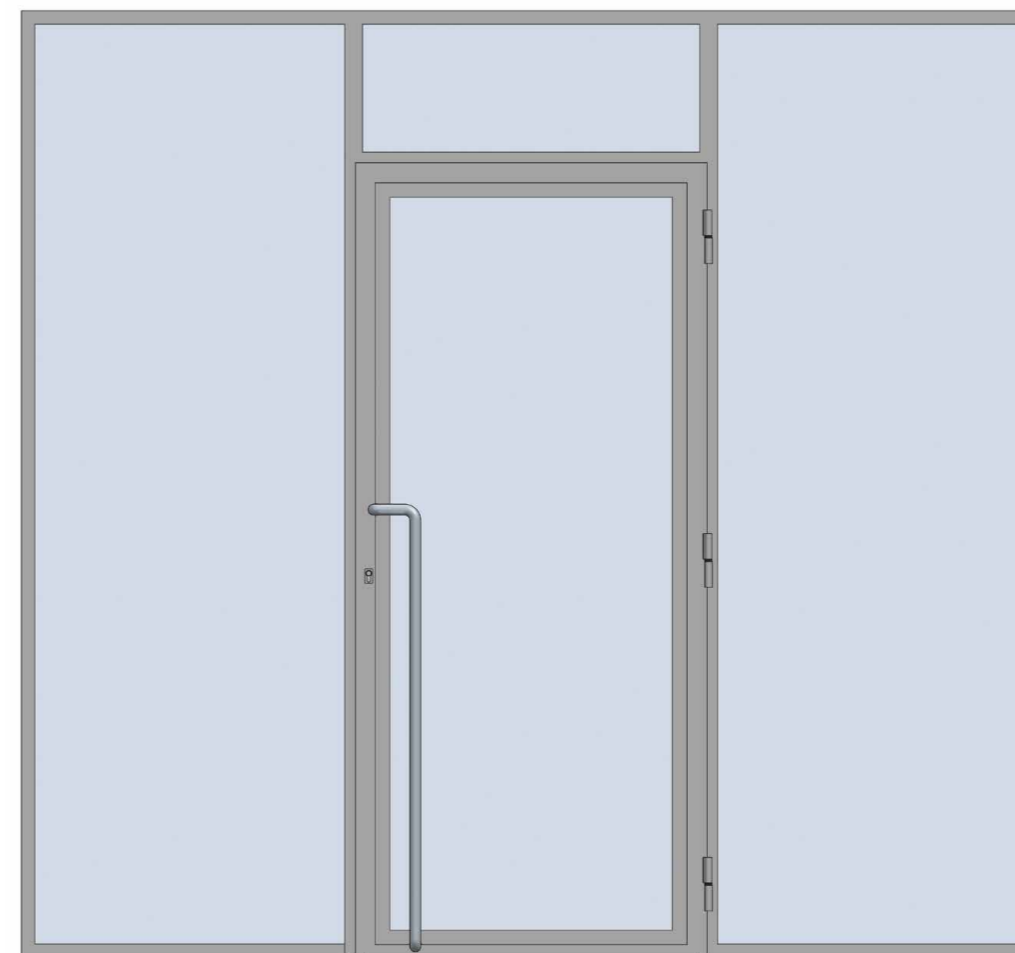

Vetrina con 3 specchiature fisse + porta con cornice liscia
Triple fixed shop-window with smooth-framed door
Vitrine avec 3 miroirs fixes + porte avec cadre lisse

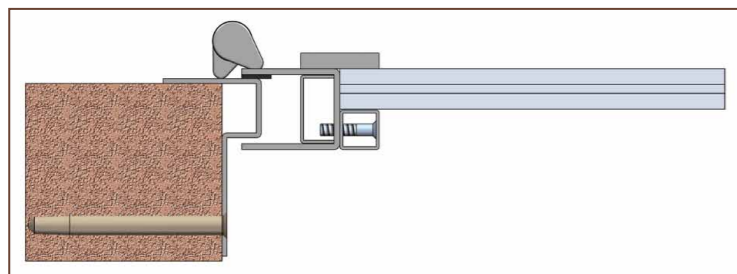

Nodo a sormonto con vetro 8+8
8+8 overlapping hinge with glass
Nœud se superposant avec verre 8+8

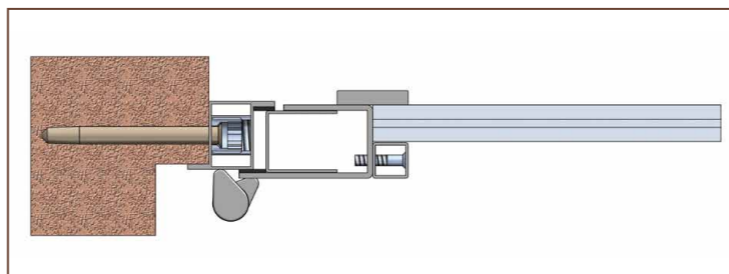

Nodo complanare con vetro 8+8
8+8 coplanar hinge with glass
Nœud à fleur de surface avec verre 8+8

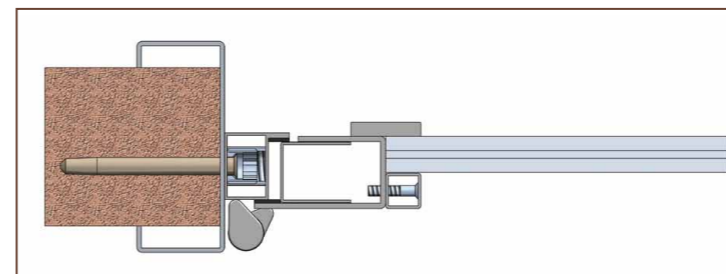

Nodo complanare con imbotte con vetro 8+8
8+8 coplanar hinge with intrados, with glass
Nœud à fleur de surface avec intrados et verre 8+8

ISTITUTO GIORDANO	
<p>RAPPORTO DI PROVA N. 334959</p> <p>Lungo e dati di emissione: Bellaria Igea Marina - Italia, 30/06/2016</p> <p>Committente: PROART S.r.l. - Viale Montecanto 1/3 - 20142 MILANO (MI) - Italia</p> <p>Data della richiesta della prova: 26/05/2016</p> <p>Numero e data della commessa: 69218, 26/05/2016</p> <p>Data del ricevimento del campione: 30/05/2016</p> <p>Data dell'esecuzione della prova: 04/05/2016</p> <p>Oggetto della prova: resistenza all'effluviazione e classificazione (resistenza sotto carico statico, resistenza sotto carico dinamico e resistenza all'azione manuale di effluviazione) secondo le norme UNI EN 1627:2011, UNI EN 1628:2011, UNI EN 1629:2011 e UNI EN 1630:2011 in versione completa</p> <p>Lungo della prova: Istituto Giordano S.p.A. - Via Erbesa, 72 - 47043 Gattico (FC) - Italia</p> <p>Provenienza del campione: campionario fornito dal Committente</p> <p>Identificazione del campione in accettazione: n. 2054/0500</p> <p>Descrizione del campione: Il campione sottoposto a prova è denominato "SERBAMENTO/PRESERVA DI SICUREZZA".</p>	
<p>RAPPORTO DI PROVA N. 334960</p> <p>Lungo e dati di emissione: Bellaria Igea Marina - Italia, 30/06/2016</p> <p>Committente: PROART S.r.l. - Viale Montecanto 1/3 - 20142 MILANO (MI) - Italia</p> <p>Data della richiesta della prova: 26/05/2016</p> <p>Numero e data della commessa: 69218, 26/05/2016</p> <p>Data del ricevimento del campione: 30/05/2016</p> <p>Data dell'esecuzione della prova: 04/05/2016</p> <p>Oggetto della prova: resistenza all'effluviazione e classificazione (resistenza sotto carico statico, resistenza sotto carico dinamico e resistenza all'azione manuale di effluviazione) secondo le norme UNI EN 1627:2011, UNI EN 1628:2011 e UNI EN 1629:2011 in versione completa</p> <p>Lungo della prova: Istituto Giordano S.p.A. - Via Erbesa, 72 - 47043 Gattico (FC) - Italia</p> <p>Provenienza del campione: campionario fornito dal Committente</p> <p>Identificazione del campione in accettazione: n. 2054/0500</p> <p>Descrizione del campione: Il campione sottoposto a prova è denominato "SERBAMENTO/PRESERVA DI SICUREZZA - CLASSE F".</p>	

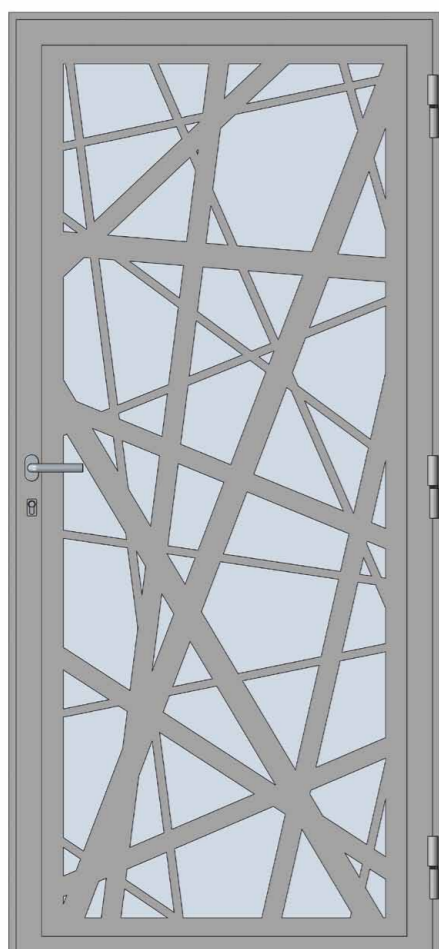

Porta con lavorazione pitagora
"Pitagora" model door
Porte avec usinage "Pitagora"

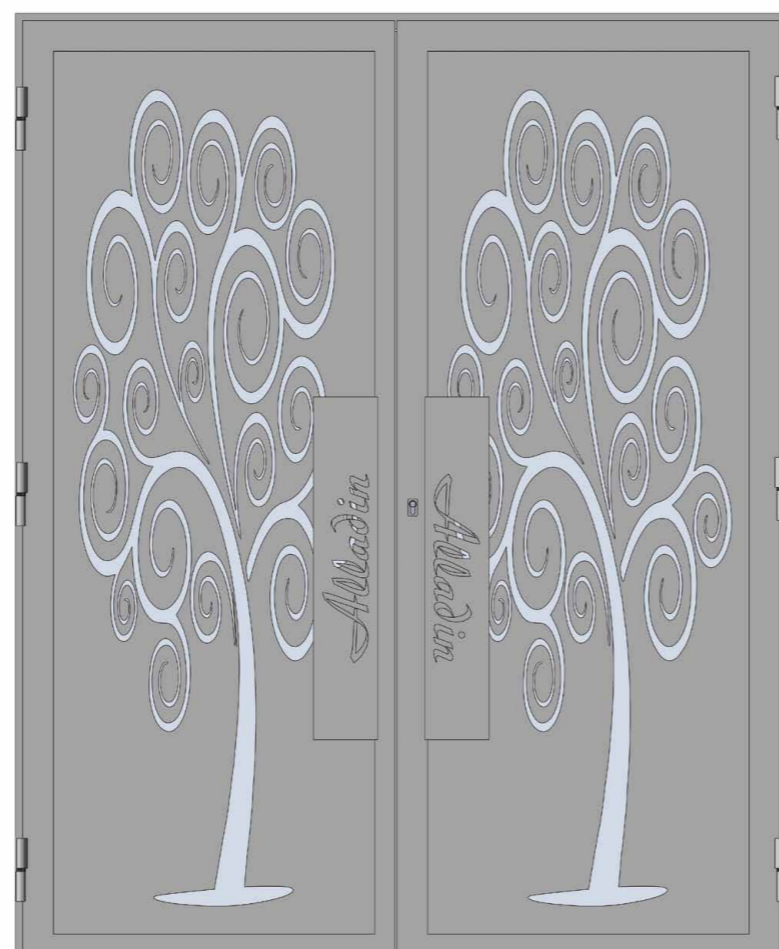

Portoncino 2 ante apribili con lavorazione bonsai e maniglioni tagliati al laser
"Bonsai" model double door, fully openable, with laser cut handles
Porte 2 battants avec usinage "Bonsai" et poignées coupées au laser

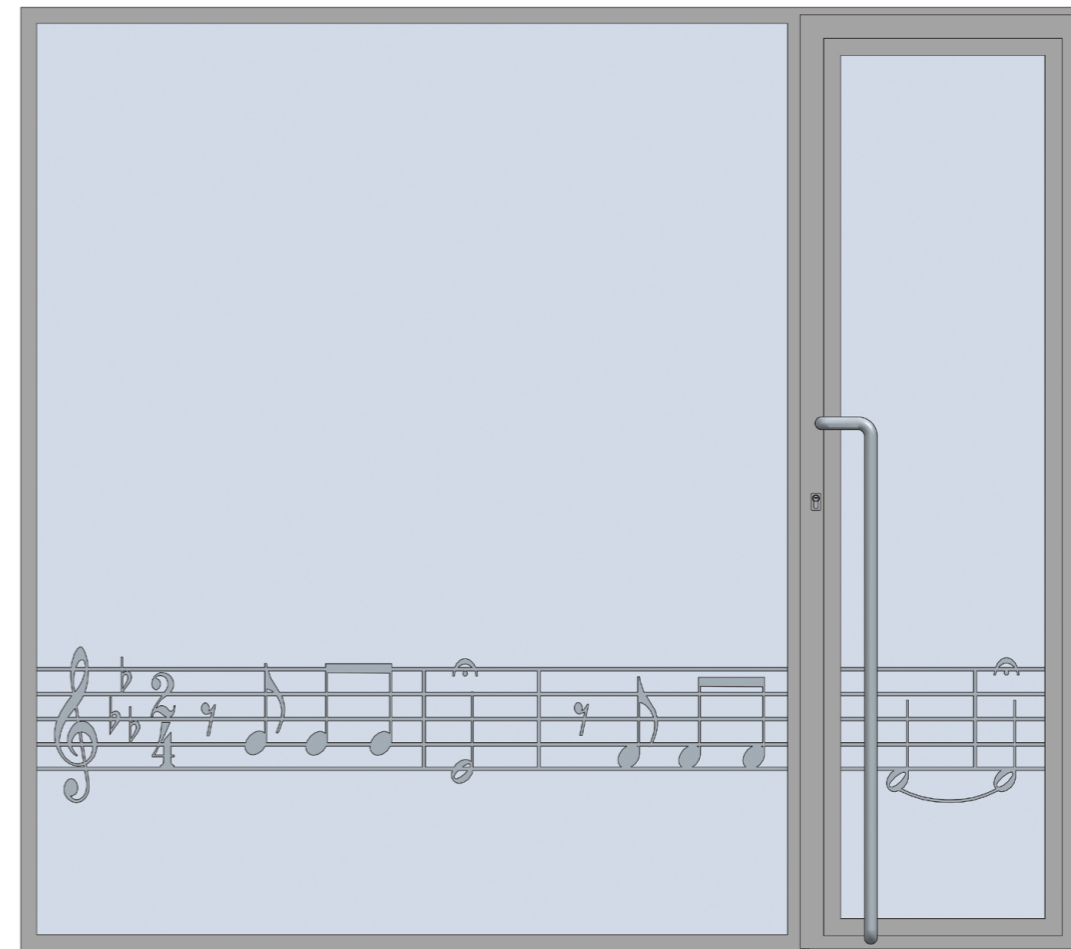

Vetrina con finiture pentagramma su vetro
"Pentagramma" model shop-window, with decorated glass
Vitrine avec finition "Pentagramma" sur verre

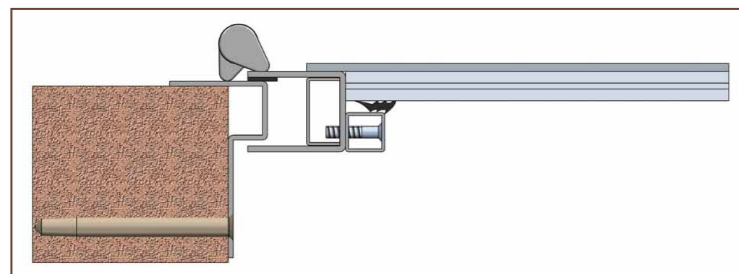

Nodo a sormonto con lamiera con vetro 6+6
6+6 overlapping hinge with sheet metal and glass
Nœud se superposant avec plaque et verre 6+6

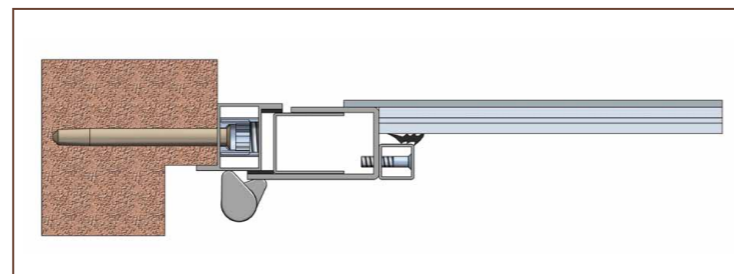

Nodo complanare con lamiera con vetro 6+6
6+6 coplanar hinge with sheet metal and glass
Nœud à fleur de surface avec plaque et verre 6+6

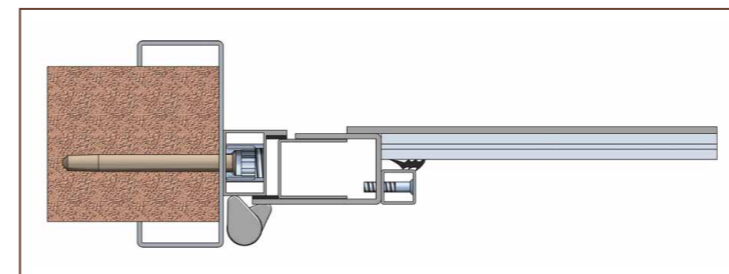

Nodo complanare lamiera con imbotte con vetro 6+6
6+6 coplanar hinge with sheet metal and glass, with intrados
Nœud à fleur de surface avec intrados et verre 6+6



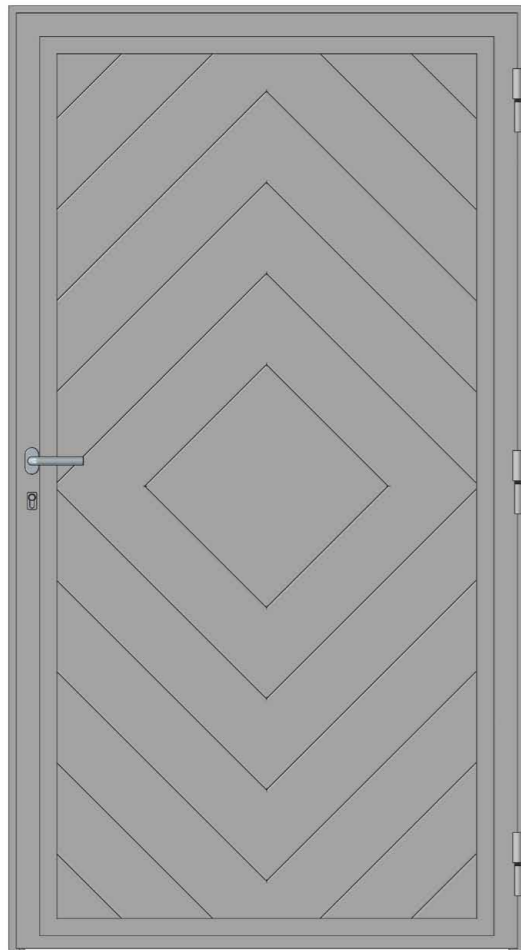

Porta con doghe a rombo
Diamond-shaped slat door
Porte avec lattes en losange

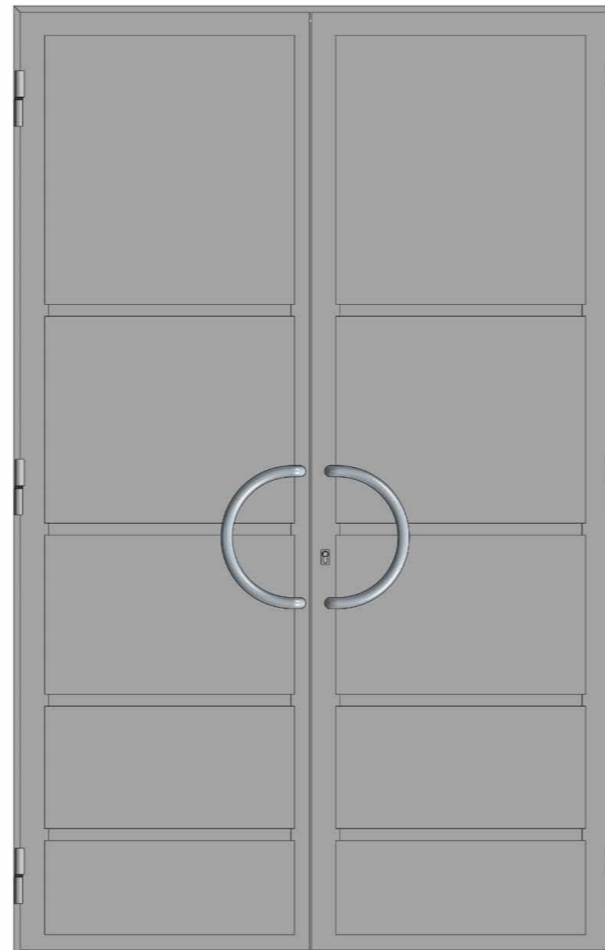

Portoncino cieco con fughe orizzontali
Solid reinforced door with horizontal joints
Porte aveugle avec joints horizontaux

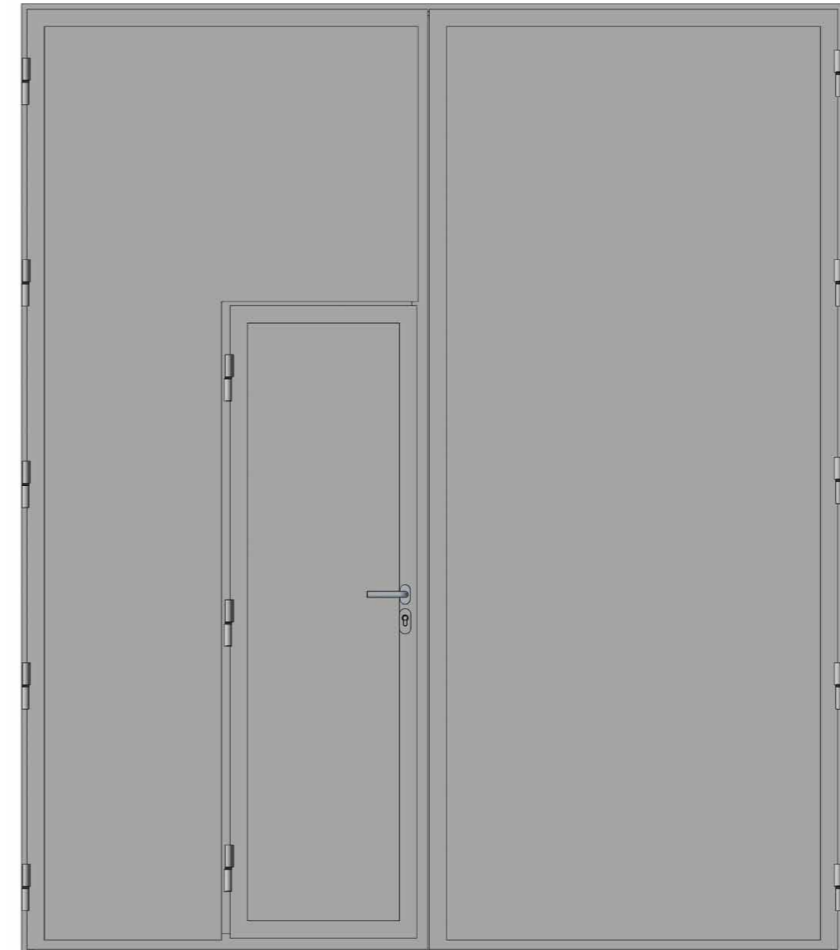

Portone cieco con porta inserita
Solid reinforced door with inner door
Porte aveugle avec porte insérée

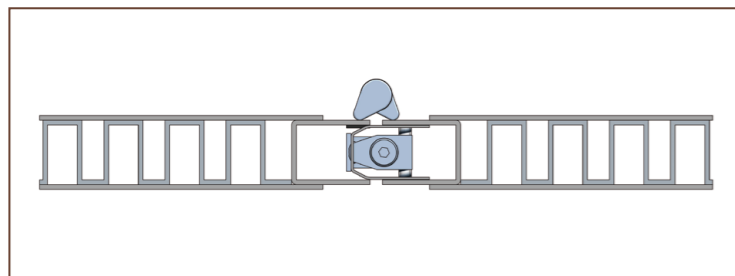

Nodo centrale maschio/femmina con doppia lamiera
Central male-female hinge, with double sheet metal
Nœud central mâle-femelle avec double plaque

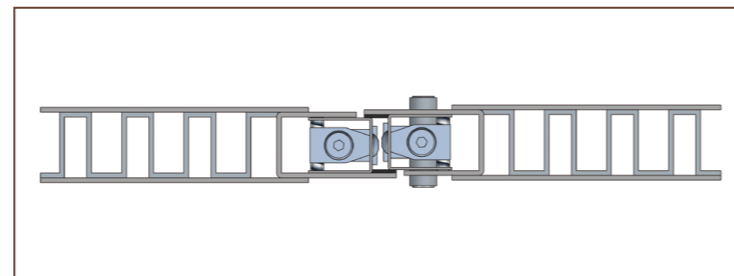

Nodo centrale doppio battente con doppia lamiera
Central double swing hinge, with double sheet metal
Nœud central à double battant avec double plaque

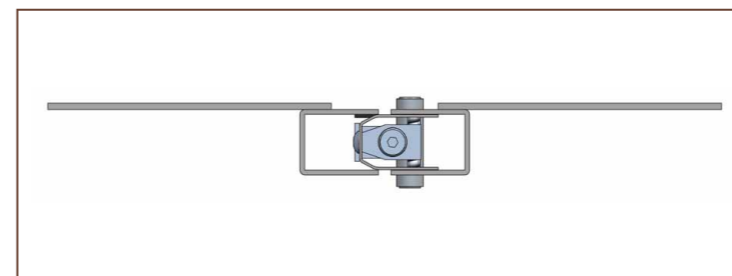

Nodo centrale maschio/femmina monolamiera
Central male-female hinge, with single sheet metal
Nœud central mâle-femelle monoplague



MANIGLIE E MANIGLIONI / HANDLES / POIGNÉES



Maniglia
Handle / Poignée
length 130mm Ø 20

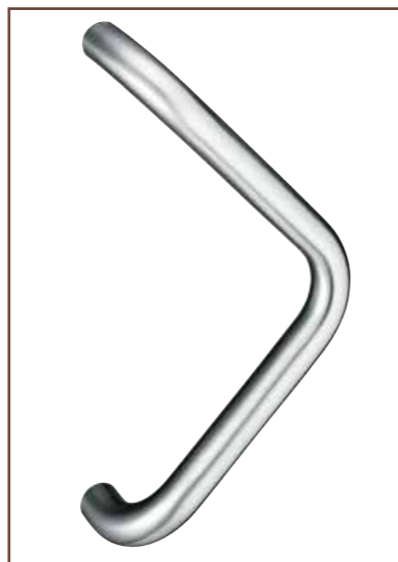

Maniglione V
V-shaped Handle / Poignée en V
H350mm Ø 30

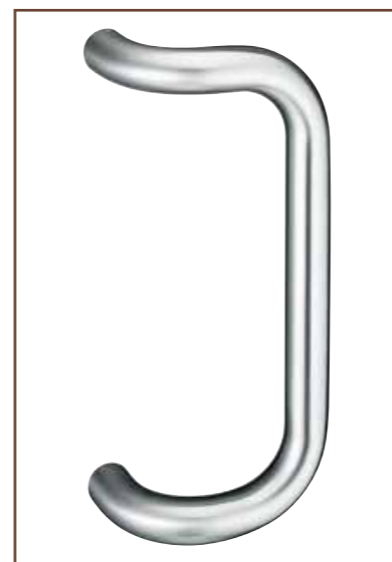

Maniglione U
U-shaped Handle / Poignée en U
H350mm Ø 30

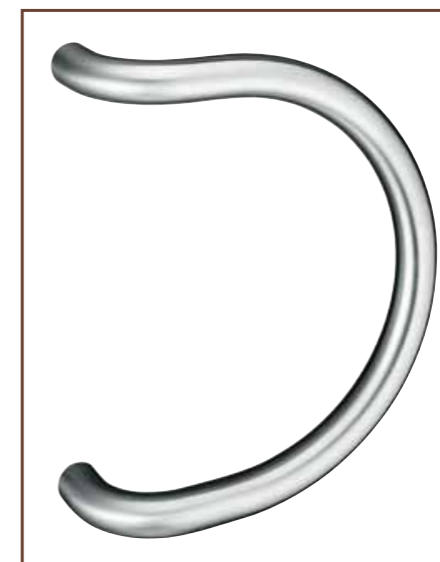

Maniglione C
C-shaped Handle / Poignée en C
H350mm Ø 30

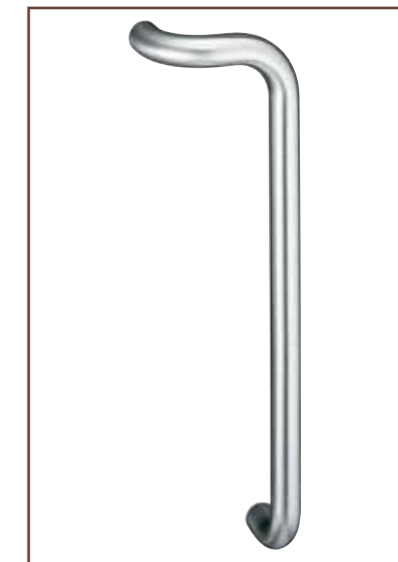

Maniglione I
I-shaped Handle / Poignée en I
H1200mm Ø 30

CORNICI E VITI / FRAMES AND SCREWS / CADRES ET VIS



Cornice liscia
Smooth frame /
Cadre lisse



Cornice martellata
Hammered frame /
Cadre façonné au marteau



Cornice sagomata
Molded frame /
Cadre profilé



Cornice martellata e stampata
Hammered and printed frame /
Cadre façonné au marteau et imprimé



Vite autoforante con testa svasata e tappo nero di finitura
Self-drilling screw with counter-sunk head and black finishing cover /
Vis autoperceuse avec tête fraisée et capuchon de finition noir



Vite passo MA con testa meccanica inox
MA-pitch screw with stainless steel mechanized head /
Vis filetage MA avec tête mécanique en acier inoxydable



Vite passo MA con testa a goccia inox
MA-pitch screw with stainless steel drop-shaped head /
Vis filetage MA avec tête goutte de suif en acier inoxydable



Vite passo MA con testa a goccia brunita
MA-pitch screw with burnished drop-shaped head /
Vis à filetage MA avec tête goutte de suif brunie

PERSIANA BLINDATA PROFILO ELEGANT

REINFORCED SHUTTER ELEGANT PROFILE
VOLET BLINDÉ PROFIL ELEGANT

Scheda tecnica / Technical sheet / Fiche technique

Con il nostro Profilo Elegant così composto: un corpo da 30/10 + un innesto da 15/10 sagomato, possiamo creare persiane di notevoli dimensioni la dove servano le alette aperte, ma anche antoni dogati sia verticali che orizzontali senza che si veda alcun tratto di saldatura, questo nonostante i nostri prodotti siano completamente saldati tra loro e non squadrettati o con plastiche applicate. Una caratteristica unica delle persiane/antoni Alladin, è l'innesto per tutta l'altezza, di un'anta nell'altra, cosa che accade anche dove viene incernierata creando un rostro anti strappo lungo tutta l'altezza del manufatto. Si può quindi affermare che una volta chiuse le ante la persiana Alladin diventa un blocco unico molto resistente testato in classe 3 e 4 antieffrazione. Altro particolare da non trascurare è la possibilità di regolare i puntali pieni da 18mm, questo renderà possibile la perfetta regolazione tramite brugole sia all'installazione che successivamente in caso di assestamenti.

With our "Elegant" Profile (including a 30/10 body with a 15/10 moulded joint) we can create shutters of significant size where open fins are needed, but also slatted doors, both vertical and horizontal, with no visible welding lines; this holds true even though our products are completely welded and sport no brackets or plastic applications. A unique feature of Alladin shutters is the full-length insertion of each shutter into the next, even at the hinges – where this creates an anti-rip guard for the whole length of the product. This means that once the doors are closed the Alladin shutter becomes a single, very tough block, certified as burglar-proof class 3 and 4. Another important detail is the possibility of calibrating the 18mm full caps, which allows for perfect calibration, both at installation and for later adjustments, through a simple Allen key.

Avec notre Profil Elegant, composé comme suit : un corps de 30/10 + un joint profilé 15/10, nous pouvons créer de grands volets, si les ailes ouvertes sont nécessaires, mais aussi des battants à lattes verticales et horizontales, sans traces de soudure apparentes, alors même que nos produits sont complètement soudés entre eux, sans joints ou applications en plastique. Une caractéristique unique des volets/battants Alladin est le raccord pour toute la hauteur d'un battant dans l'autre, qui arrive aussi là où ils sont articulés, en réalisant une protection anti-déchirure sur toute la hauteur du produit. On peut donc dire que le volet Alladin, avec les battants fermés, devient un monobloc très résistant, testé pour les classes 3 et 4 contre les effractions. Une autre caractéristique importante à mentionner est la possibilité d'ajuster les mandrins de fermeture pleins de 18mm. Cela permettra un réglage parfait avec des clés Allen au moment de l'installation et dans le cas d'ajustages ultérieurs.

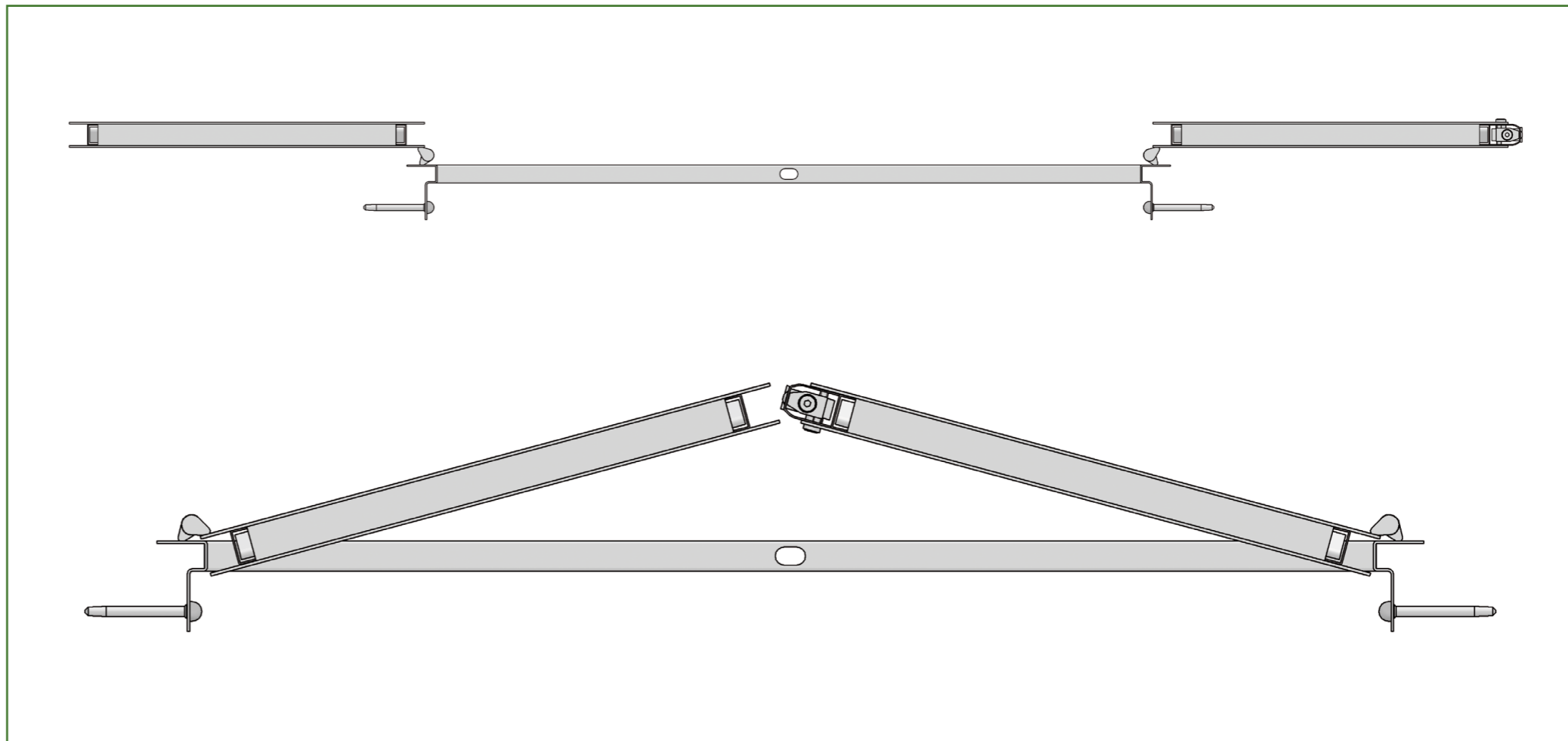

LEGENDA

- 1 - Telaio sagomato aperto spessore 25/10 misure standard 90 e 60mm.
- 2 - Semichiuso a "C" spessore 25/10 misure 30x30mm.
- 3 - Serratura a montante con 3 punti di chiusura azionata con cilindro europeo a spine unificato.
- 7 - Tasselli in nylon con vite in acciaio a testa svasata e chiave ad inserto torx adibiti al fissaggio del telaio, dotati di apposita stellina antisvito e tappo in plastica nera di finitura.
- 8 - Profilo a C 30/10 che funge da rostro per tutta l'altezza e da inserimento alette.
- 11 - Puntale di chiusura diametro 18mm regolabile.
- 14 - Cerniera a goccia dotata di cuscinetto in acciaio, saldata da 150mm.
- 15 - Cerniera a collo lungo per apertura ante ad impacchettamento regolabile in altezza.
- 17 - Asola su telaio per inserimento puntale.
- 24 - Alette arrotondate 50x10 spessore 15/10.
- 28 - Coprifilo di rifinitura applicata al telaio sagomato.

KEY

- 1 - Open moulded frame, thickness 25/10, standard measurements 90 and 60 mm.
- 2 - Half-closed, C shape, thickness 25/10, measurements 30x30 mm.
- 3 - Lock pillar with 3 closing points, activated through European unified pin tumbler cylinder.
- 7 - Nylon dowels with countersunk headed steel screw and torx wrench insert for frame fixing, with security star and finishing black plastic cover.
- 8 - 30/10 C-Profile acting as guard and fin insertion for the whole profile length.
- 11 - Closing cap, 18 mm diameter, adjustable.
- 14 - Drip hinge with steel bearing, welded, 150 mm.
- 15 - Long neck hinge for shutter opening – height-adjustable.
- 17 - On-frame loop for cap insertion.
- 24 - Rounded 50/10 fins, thickness 15/10.
- 28 - Finishing strap, applied to the moulded frame.

LÉGENDE

- 1 - Châssis ouvert en forme, épaisseur 25/10, dimension standard 90 et 60mm.
- 2 - Semi-fermée en « C », épaisseur 25/10, dimension 30x30mm.
- 3 - Serrure à montant avec 3 points de fermeture, actionnée avec un cylindre profil européen à goupilles unifié.
- 7 - Les goujons en nylon avec vis en acier à tête fraisée et clé torx pour fixer le châssis, équipés avec une étoile antivolt spécifique et d'un capuchon de finition en plastique noir.
- 8 - Profil en C 30/10, qui sert comme protection sûr toute la hauteur et pour l'insertion des ailes.
- 11 - Mandrin de fermeture de diamètre 18 mm réglable.
- 14 - Charnière soudée en forme de goutte 150mm, équipée d'un palier en acier.
- 15 - Charnière à long col pour des battants pliants, réglable en hauteur.
- 17 - Œillet sur le châssis pour l'insertion du mandrin.
- 24 - Ailes arrondies 50x10 d'épaisseur 15/10.
- 28 - Profilé de complément appliqué sur le châssis modelé.



Apertura a ribalta con cerniera a collo lungo
Flap opening with long neck hinge / Ouverture basculante avec charnière à col long

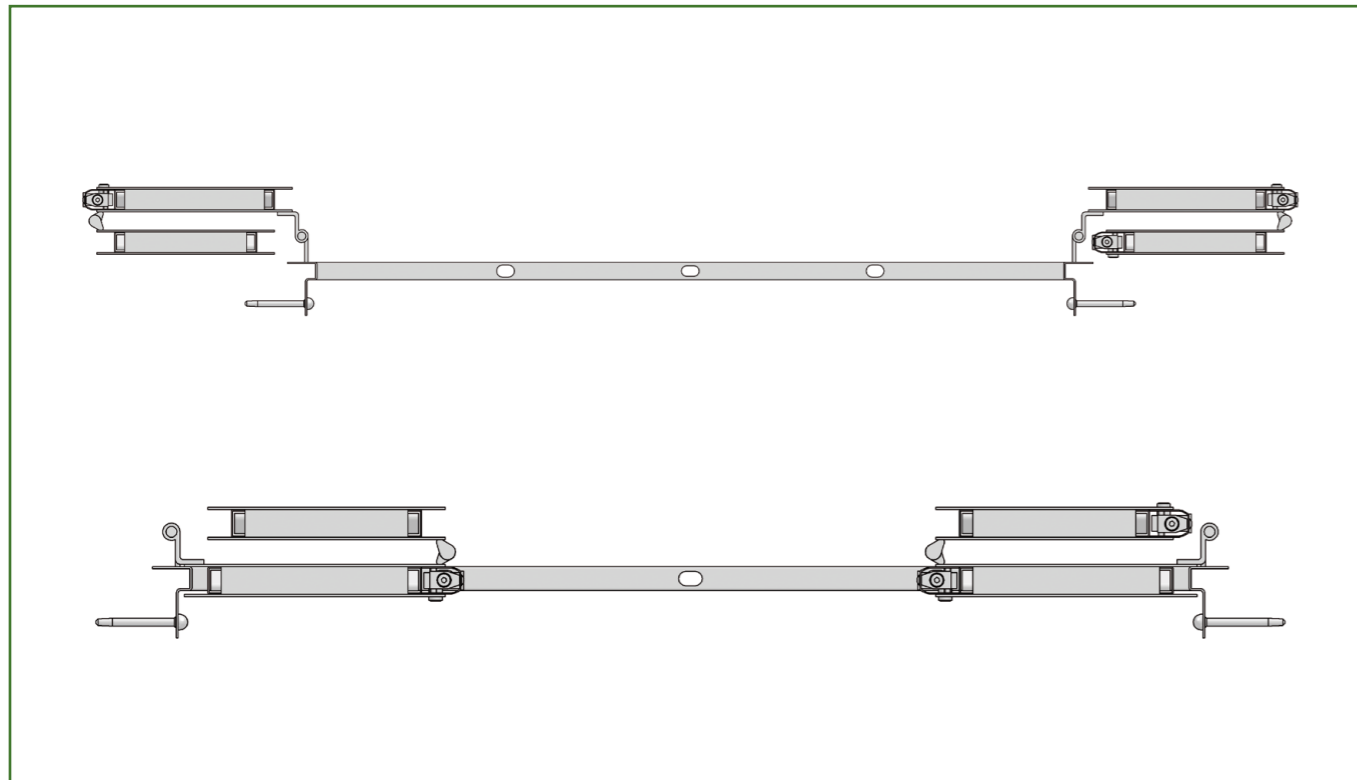

Apertura a libro con extra serrature
Hinged opening with extra locks / Ouverture pliante avec serrures supplémentaires

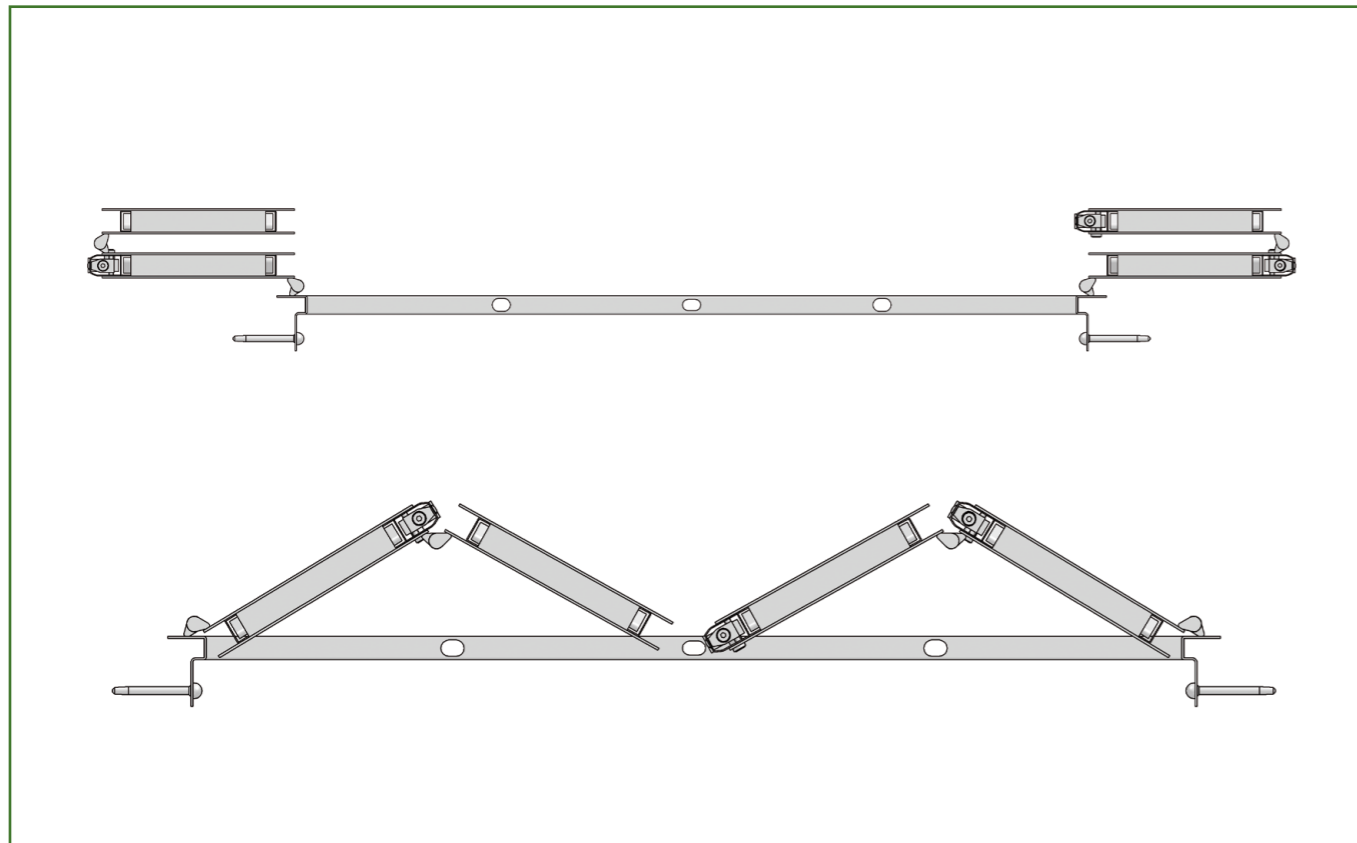

Nodo centrale
Central hinge / Nœud central

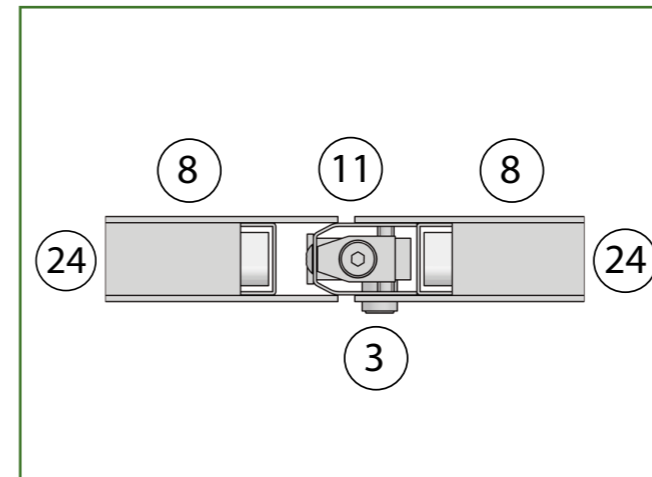

Nodo 3/4 anta
Hinge at 3/4 of shutter / Nœud battant 3/4

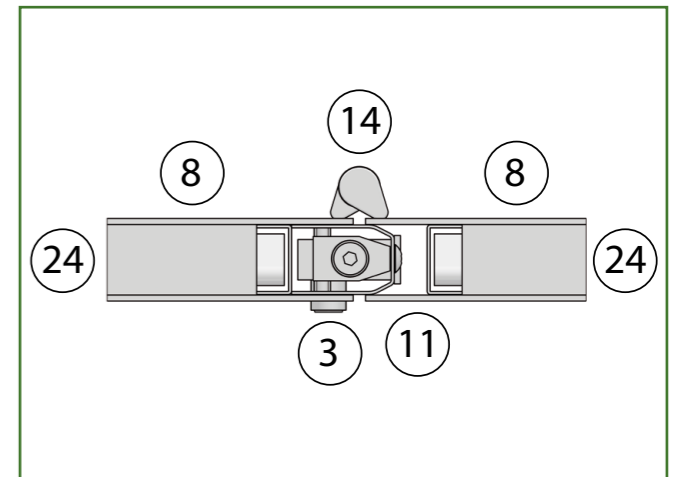

Nodo collo lungo
Long neck hinge / Nœud à col long

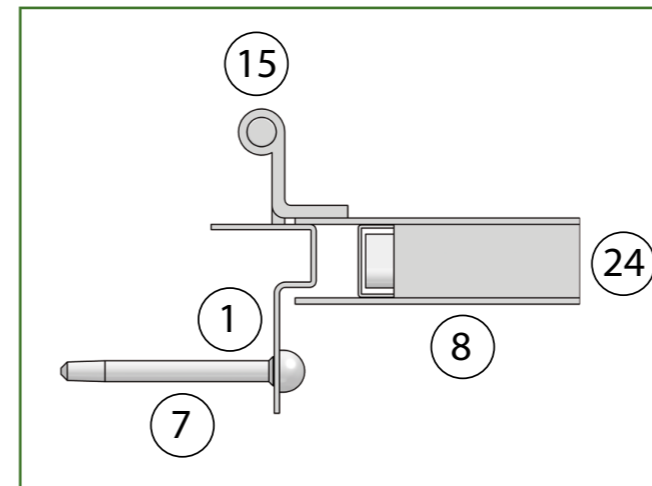

Nodo anta telaio
Shutter-frame hinge / Nœud battant châssis

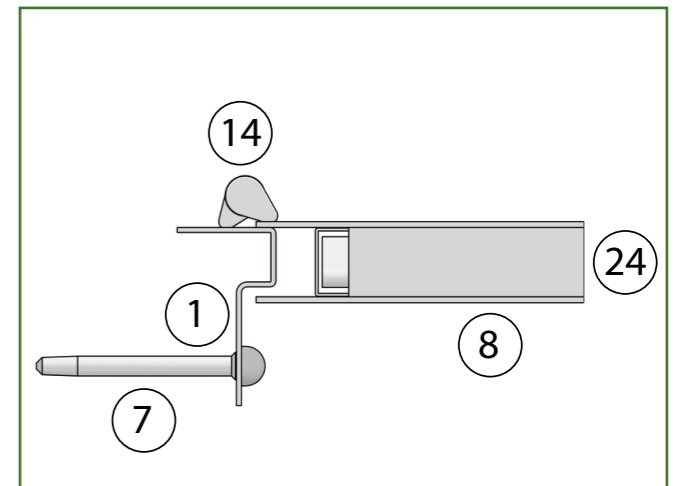

Nodo serratura su telaio
Lock on frame hinge / Nœud serrure sur châssis

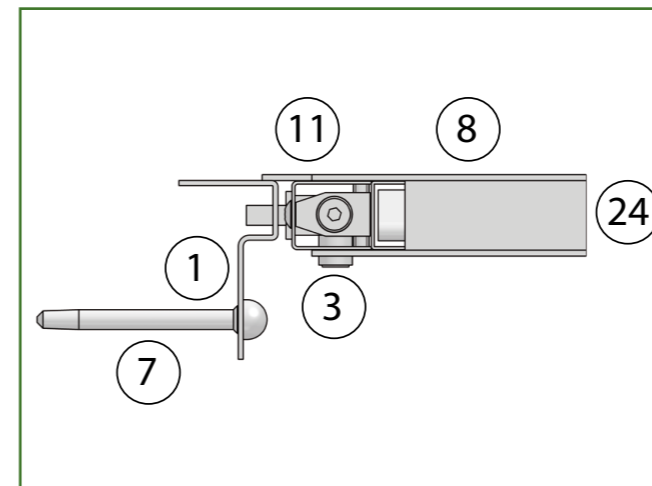

Nodo sagomato più coprifilo
Moulded hinge with strap / Nœud modelé avec profilé

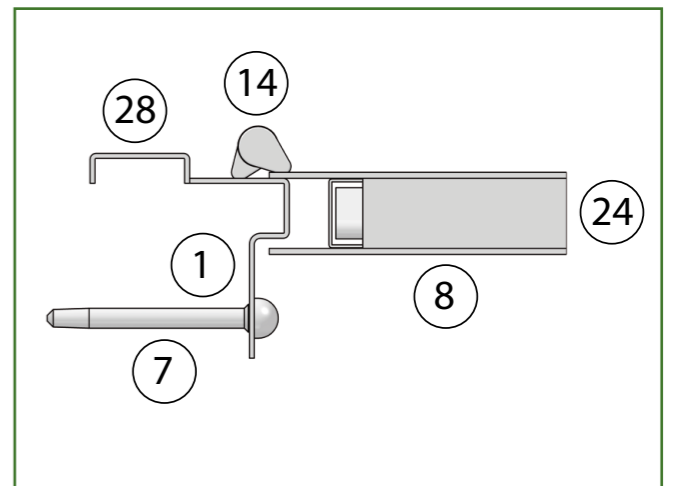

PERSIANA BLINDATA SCORREVOLI

REINFORCED SHUTTER SLIDING
VOLET BLINDÉ COULISSANTS

Scheda tecnica / Technical sheet / Fiche technique

Si possono realizzare in più versioni: scorrevole interno muro e scorrevole esterno muro. Lo scorrevole interno muro viene posizionato all'interno di uno scrigno predisposto nella mazza della finestra mentre lo scorrevole esterno muro viene posizionato all'esterno. Entrambe le tipologie possono prevedere un'apertura ad ante sovrapposte o speculari.

Both internal and external sliding mechanisms can be installed. Internal sliding shutters are mounted inside a container within the window's reveal, while external sliding shutters are directly mounted outside the wall. Both kinds can have a mirror or overlapping opening configuration.

Il est possible de les réaliser en plusieurs versions : coulissant à l'intérieur du mur et coulissant à l'extérieur du mur. Le coulissant à l'intérieur du mur est placé dans un écrin prévu dans le dormant de la fenêtre, alors que le coulissant à l'extérieur du mur est placé à l'extérieur. Les deux typologies peuvent disposer d'une ouverture avec des battants superposés ou spéculaire.

Scorrevole in Scrigno / Sliding - with in-wall container / Coulissant en écrin

Esterno abitazione

Outside the house / Extérieur de l'habitation **11**

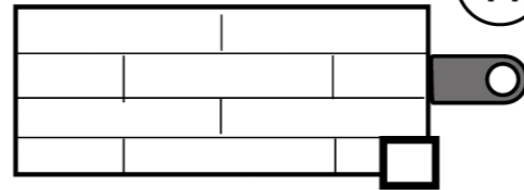

Interno abitazione

Inside the house / Intérieur de l'habitation

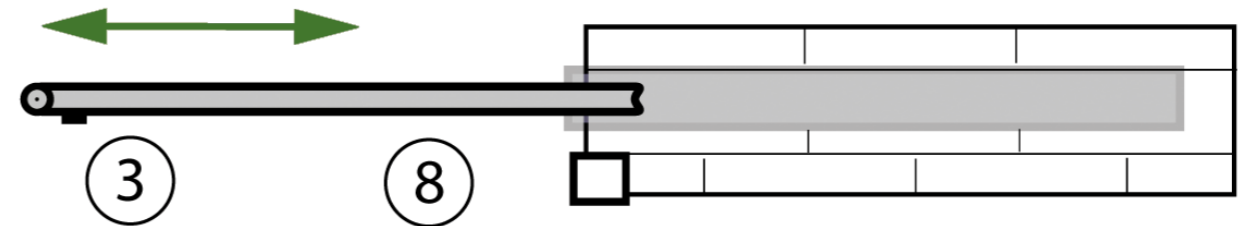

Persiana da agganciare su binario Scrigno già esistente

Shutter designed to be attached to pre-existing in-wall container
Volet à accrocher sur une guide, écrin préexistante

Scorrevole in vano muro / Sliding - in-wall / Coulissant dans l'ouverture du mur

Esterno abitazione

Outside the house / Extérieur de l'habitation **11**

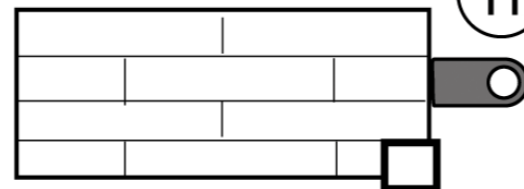

Interno abitazione

Inside the house / Intérieur de l'habitation

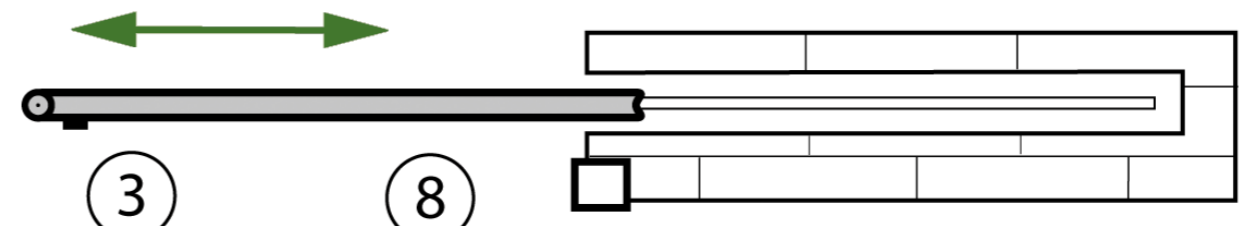

Persiana fornita completa di binari e carrelli

Shutter with rail and wheels
Volet équipé complet de chenilles et de chariots

Scorrevole esterno muro / Sliding - out of the wall / Paroi coulissante externe

Mantovana / Inglese / Francese

Esterno abitazione

Outside the house / Extérieur de l'habitation **11**

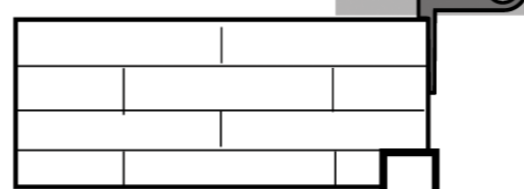

Interno abitazione

Inside the house / Intérieur de l'habitation

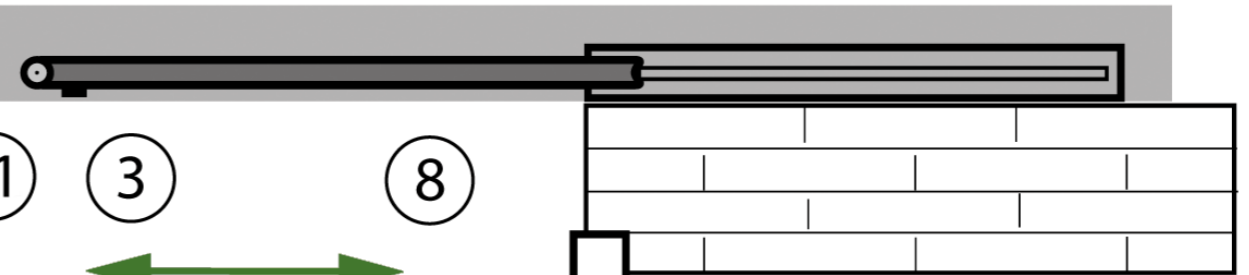

Persiana fornita completa di binari, carrelli e mantovana

Shutter with rail and wheels, with pelmet
Volet équipé complet de guides, chariots et cantonnière



LEGENDA

- 3** - Serratura a montante con 3 punti di chiusura azionata con cilindro europeo a spine unificato.
- 8** - Profilo a C 30/10 che funge da rostro per tutta l'altezza e da incremento alette.
- 11** - Puntale di chiusura diametro 18mm regolabile.



KEY

- 3** - Lock pillar with 3 closing points, activated through European unified pin tumbler cylinder.
- 8** - 30/10 C-Profile acting as guard and fin insertion for the whole profile length.
- 11** - Closing cap, 18 mm diameter, adjustable.



LÉGENDE

- 3** - Serrure à montant avec 3 points de fermeture, actionnée avec un cylindre profil européen à goupilles unifié.
- 8** - Profil en C 30/10, qui sert comme protection sûr toute la hauteur et pour augmenter les ailettes.
- 11** - Mandrin de fermeture de diamètre 18 mm réglable.

Persiana stecca aperta
Open-slat shutter
Volet lattes ouvertes

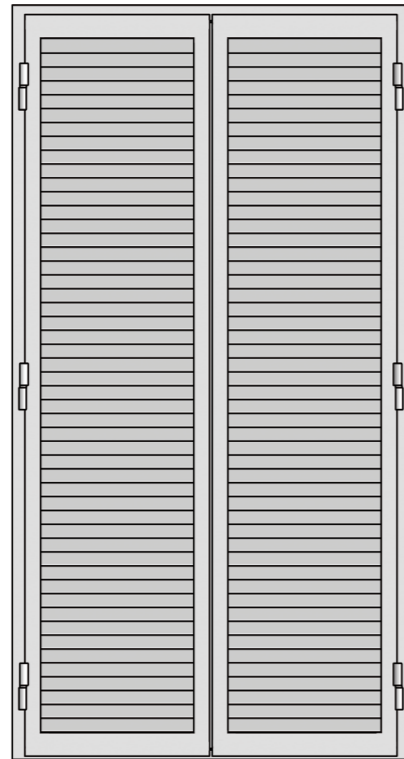

Antone doghe verticali
Vertical slat door
Battant lattes verticale

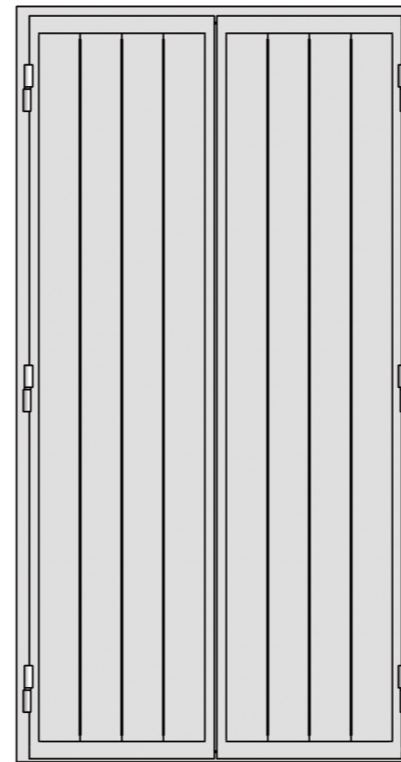

Persiana a trapezio
Trapezoid shutter
Volet trapézoïdal



Persiana stecca aperta con sportelli
Open-slat shutter with small doors
Volet lattes ouvertes avec petites portes

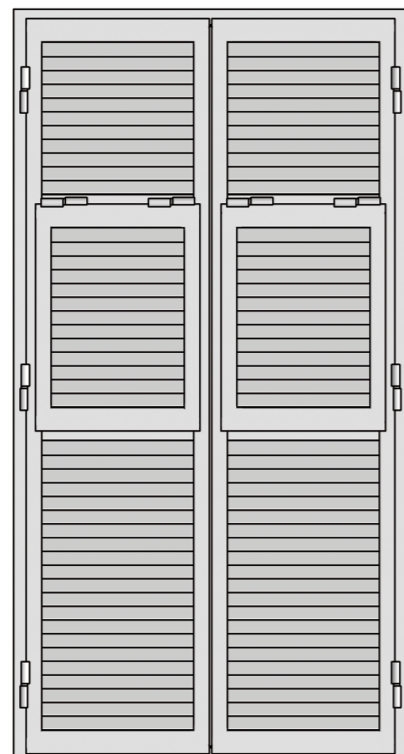

Antone doghe orizzontali
Horizontal slat door
Battant lattes horizontales



Persiana ad arco tutto sesto
Round arch shutter
Volet en arc plein cintre

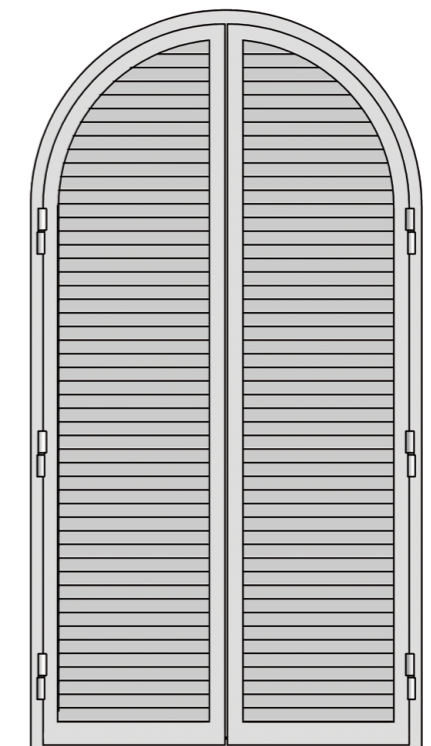

CANCELLO DI SICUREZZA CARDINE

SECURITY GATE HINGE
GRILLE DE SÉCURITÉ PAUMELLE

Scheda tecnica / Technical sheet / Fiche technique



E' frequente trovarsi in presenza di tapparelle, soprattutto in città, questo è il caso nel quale l'apertura ideale è quella verso l'esterno. Come mostrano le immagini in queste pagine, i cancelli vengono posti allineati alla superficie esterna del muro. Il telaio, per finire la migliore rifinitura, ricopre lo spigolo del muro per alcuni centimetri in modo tale da nascondere le eventuali imperfezioni dello stesso e per non mostrare lo spazio che si ha tra il telaio del cancello e il muro che, per quanto piccolo, degrada sensibilmente l'estetica dell'insieme.



Often, especially in the city, blinds are installed on windows; in these cases, the ideal opening for security grilles is outward. As pictures show, gates are mounted in line with the outer surface of the wall. The fixture covers the wall's edge for several inches, in order to offer the best possible finish, hiding potential imperfections and the space between the wall and the gate itself, which - however minor - might compromise the aesthetics of the ensemble.



Surtout dans les villes on trouve souvent des volets roulants. Dans ce cas, l'ouverture idéale est vers l'extérieur. Comme les images dans ces pages le montrent, les grilles sont alignées à la surface externe du mur. Pour délivrer la meilleure finition, le châssis couvre le rebord du mur pour quelque centimètre. De cette façon on cache les éventuelles imperfections du châssis même aussi bien que l'espace entre le châssis de la grille et le mur qui, bien si petit, dérange sensiblement l'esthétique de l'ensemble.

Apertura solo esterna / Outward-only opening / Ouverture seulement vers l'extérieur

Passo 1 Step 1 / Pas 1

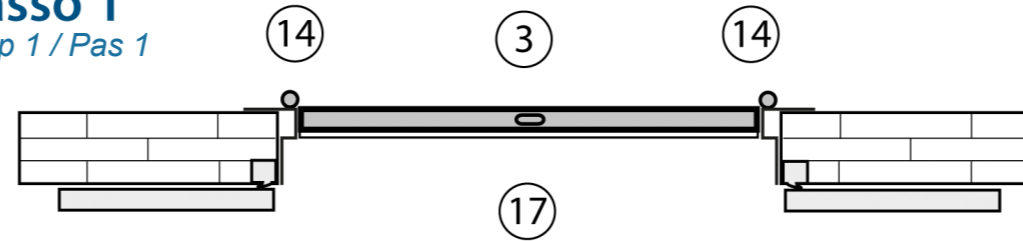

Cancello Chiuso
Closed gate / Grille fermée

Passo 2 Step 2 / Pas 2

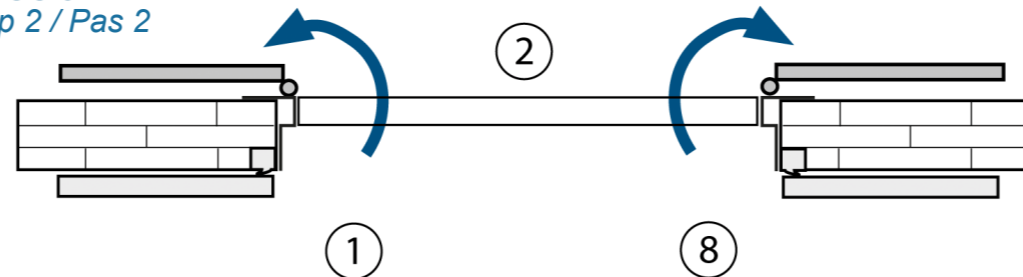

Apertura verso l'esterno
Outward opening / Ouverture vers l'extérieur

Vista laterale
Side view
Vue de côté



Sezione di fissaggio Fixing section Section de fixation

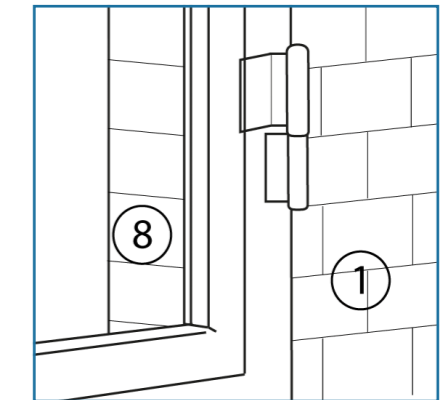
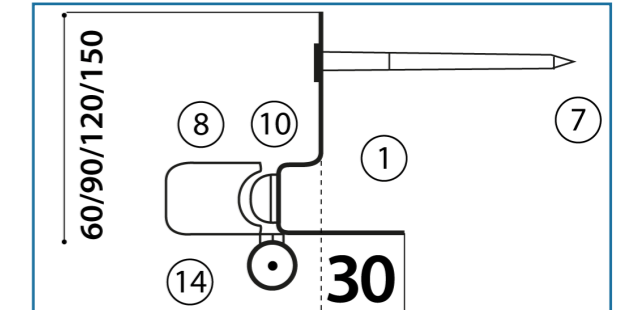

Cerniera collo lungo
Long-neck hinge
Charnière à long col

Apertura solo interna / Inward-only opening / Ouverture seulement vers l'intérieur

Passo 1 Step 1 / Pas 1

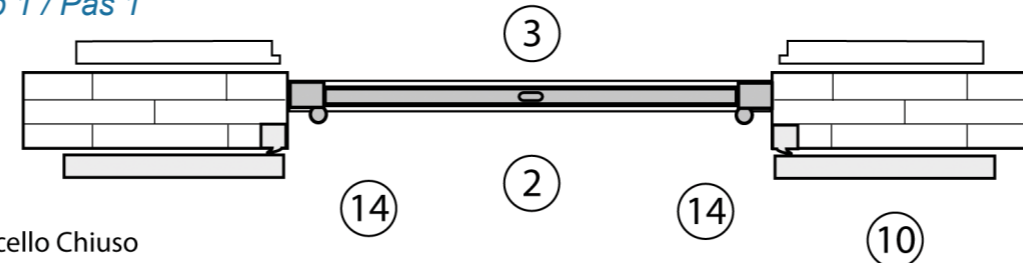

Cancello Chiuso
Closed gate / Grille fermée

Passo 2 Step 2 / Pas 2

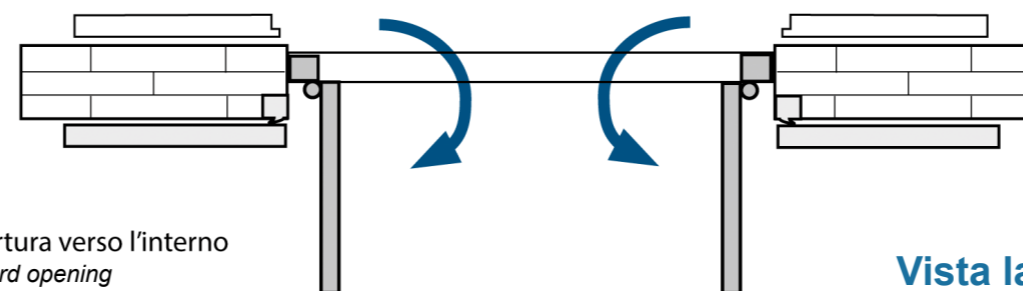

Apertura verso l'interno
Inward opening
Ouverture vers l'intérieur

Vista laterale
Side view
Vue de côté

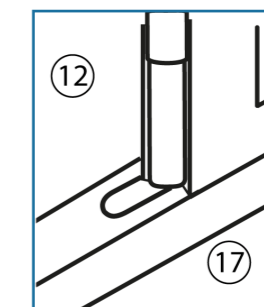
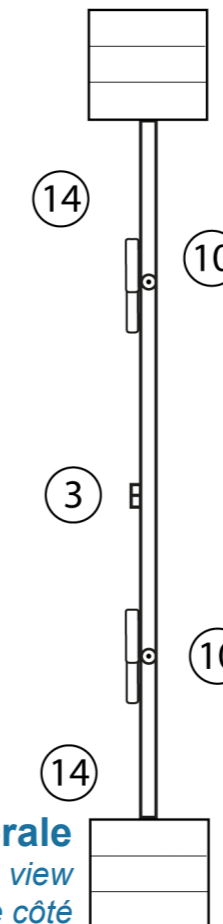

Puntale
Cap
Mandrin

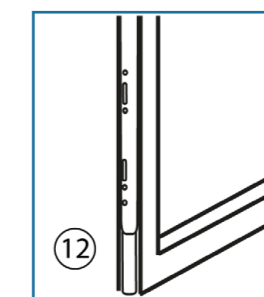

Deviatore
Diverter
Raccords

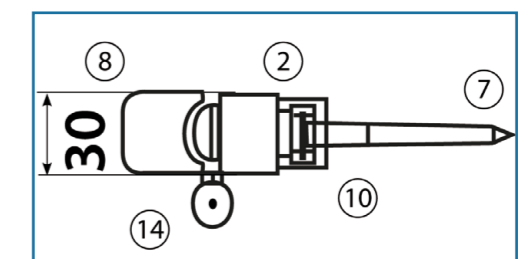

Sezione di fissaggio
Fixing section
Section de fixation

Passo 1 Step 1 / Pas 1

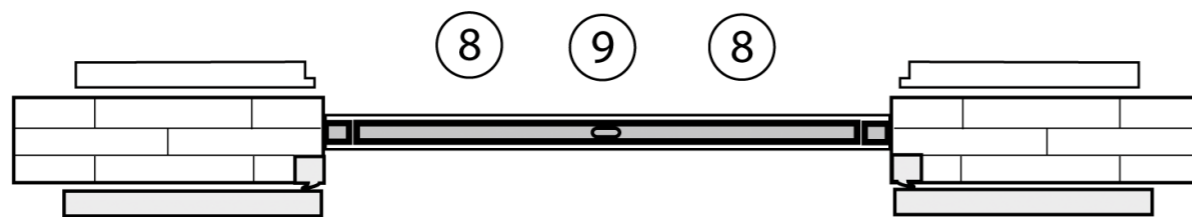

Cancello Chiuso
Closed gate / Grille fermée

Passo 2 Step 2 / Pas 2

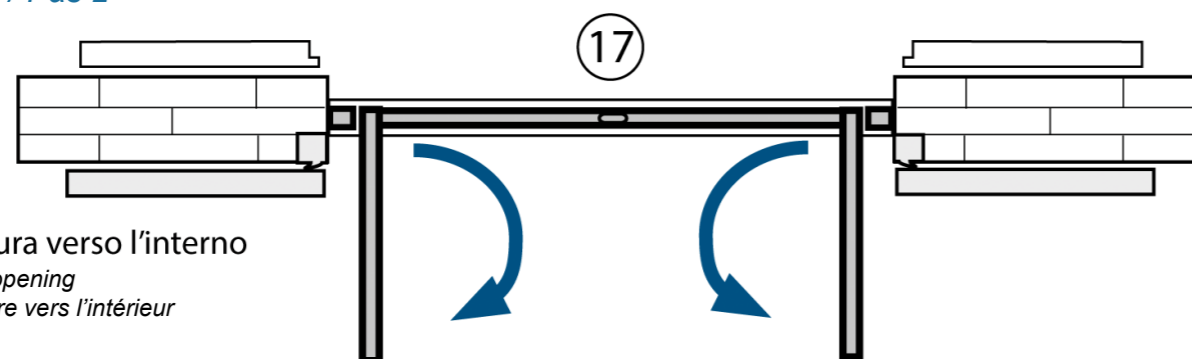

Apertura verso l'interno
Inward opening
Ouverture vers l'intérieur

Passo 3 Step 3 / Pas 3

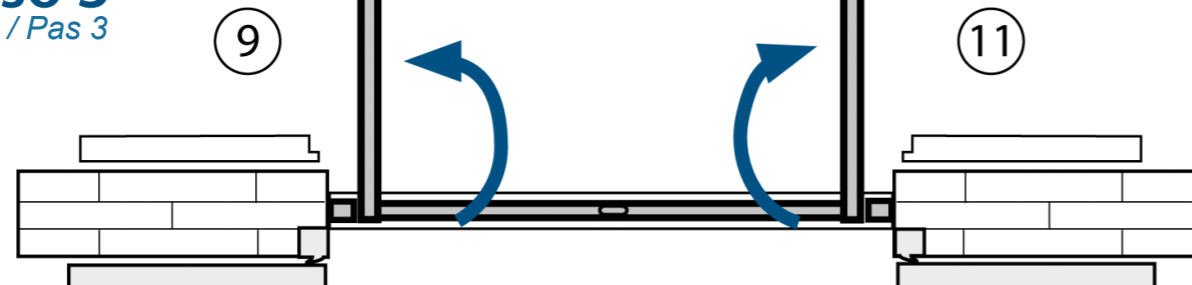

Apertura verso l'esterno
Outward opening / Ouverture vers l'extérieur

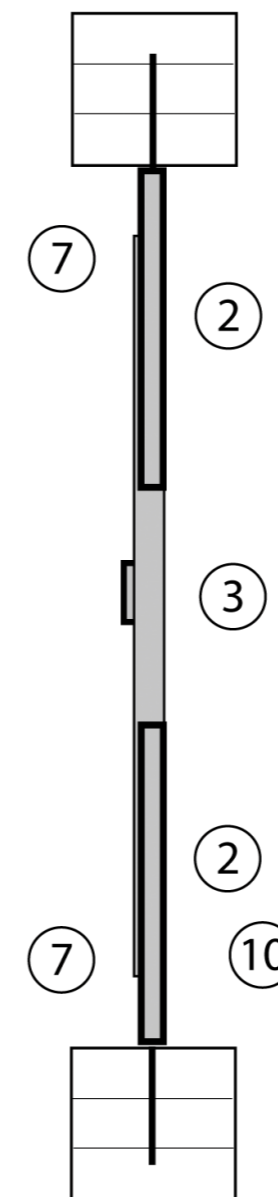

Vista laterale
Side view
Vue de côté

CANCELLO DI SICUREZZA DUAL

DUAL SECURITY GATE
GRILLE DE SÉCURITÉ DUAL

Scheda tecnica / Technical sheet / Fiche technique

Se all'esterno si ha qualche impedimento o, come accade più spesso, si dispone di persiane, è possibile ricorrere all'uso di cancelli con apertura Dual, i quali sono in grado di aprire prima verso l'interno per accedere alle persiane e successivamente aprire sino a 90° verso l'esterno. Lo spazio che viene occupato è quello presente tra le ante della persiana, poste all'esterno dell'abitazione, e il serramento interno. Questo spazio non necessita di essere particolarmente ampio: bastano poco più di tre centimetri.

If obstacles are present on the outside, or if - as is more often the case - shutters are installed, Dual-system gates and security grilles can be mounted; the Dual opening mechanism allows for grilles to be opened both inward, to access shutters, and then outward up to 90 degrees. The whole assembly occupies the space between the external shutters and the inner fixture. This needs not be particularly wide; little more than an inch can be sufficient.

En cas d'un empêchement à l'extérieur ou, comme il se passe souvent, si on a des volets, on peut utiliser les grilles de sécurité avec ouverture Dual. Celles-ci sont en mesure d'ouvrir d'abord vers l'intérieur, pour accéder aux volets, et ensuite d'ouvrir jusqu'à 90° vers l'extérieur. L'espace utilisé est celui entre les battants du volet, qui sont à l'extérieur de l'habitation, et la menuiserie à l'intérieur. Il n'est pas nécessaire que cet espace soit particulièrement ample : peu plus de trois centimètres sont suffisants.



CANCELLO DI SICUREZZA DUAL JOLLY

DUAL JOLLY SECURITY GATE
GRILLE DE SÉCURITÉ DUAL JOLLY

Scheda tecnica / Technical sheet / Fiche technique



Quando sulle finestre ci troviamo in presenza di oscuranti ad ante Jolly alla vicentina oppure alla padovana, il meccanismo Dual Jolly è la soluzione perfetta, in quanto, oltre ad aprirsi all'interno sulle finestre come il sistema Dual, questo, si apre all'esterno di 90° con le ante esterne e si ribalta a 180° oltre l'impacchettamento degli oscuranti con le ante intere come descritto nella scheda tecnica.



When windows mount Jolly-type shutters, both with outward and inward opening, the Dual Jolly opening mechanism is the idea solution, since it can open both within the windows, just like the Dual system, and outwards 90° with external shutters, reversing 180° over the folded full-door shutters, as described in the tech sheet.



En présence de volet lambris Jolly à la Vicentine ou Padouane pour les fenêtres, le mécanisme Dual Jolly est la solution parfaite. En plus de l'ouverture vers l'intérieur des fenêtres comme dans le système Dual, il offre une ouverture vers l'extérieur à 90° des battants et peut basculer à 180°, outre le pliage des volets lambris, comme décrit dans la fiche technique.

Sequenza passi per apertura / Step sequence for opening / Séquence pour l'ouverture pas à pas

Passo 1 / Step 1 / Pas 1

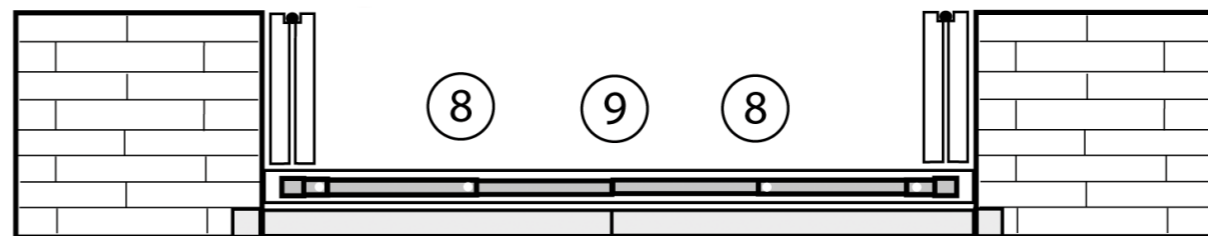

Passo 2 / Step 2 / Pas 2

Cancello Chiuso
Closed gate / Grille fermée

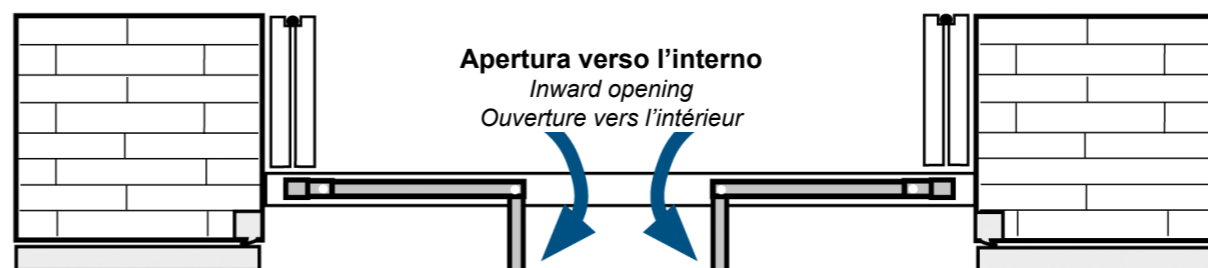

Passo 3 / Step 3 / Pas 3

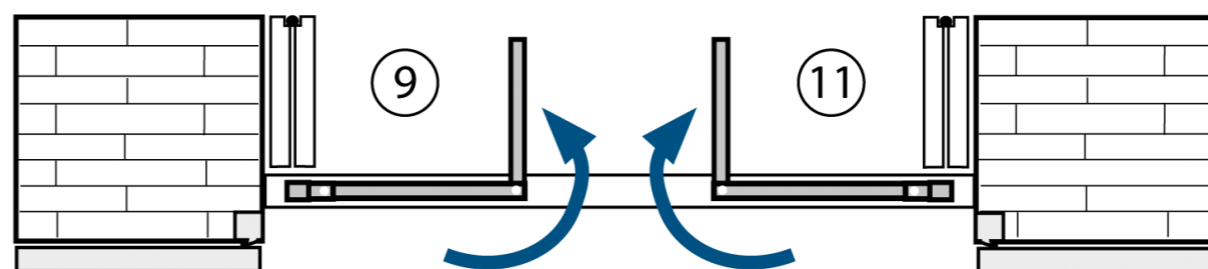

Passo 4 Step 4 / Pas 4

Apertura verso l'esterno
Outward opening
Ouverture vers l'extérieur



Tutte le ante aperte
All shutters open
Tous les battants ouverts

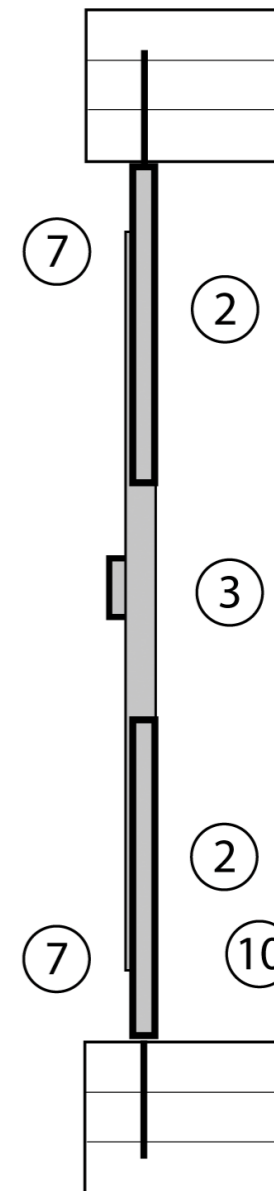

Vista laterale
Side view
Vue de côté

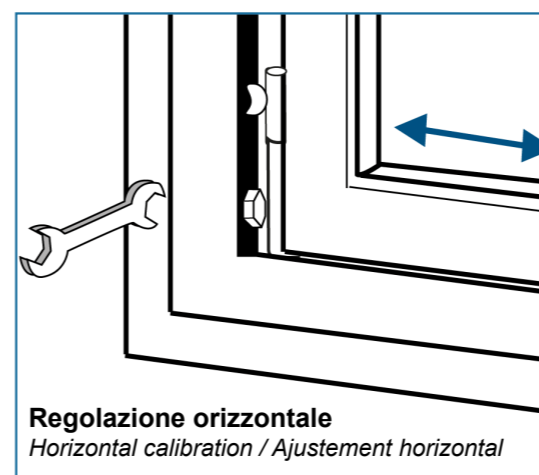

Regolazione orizzontale
Horizontal calibration / Ajustement horizontal

Particolare di innesto ante
Shutter insert - detail
Détail du raccord du battant

Passo 1
Step 1 / Pas 1

Cancello Chiuso
Closed gate / Grille fermée

Passo 2
Step 2 / Pas 2

Apertura verso l'interno
Inward opening
Ouverture vers l'intérieur

Passo 3
Step 3 / Pas 3

Apertura verso l'esterno
Outward opening / Ouverture vers l'extérieur

Passo 4
Step 4 / Pas 4

Apertura Completa verso l'esterno
All shutters open - outwards / Ouverture complète vers l'extérieur

Vista laterale
Side view
Vue de côté

Regolazione orizzontale
Horizontal calibration
Ajustement horizontal

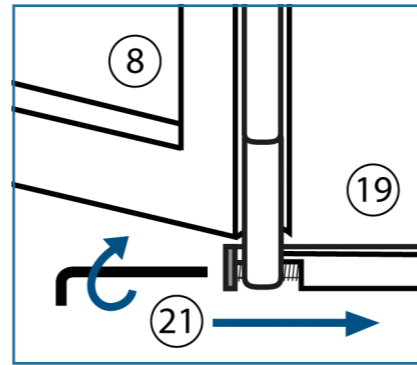

Regolazione verticale
Vertical calibration
Ajustement vertical

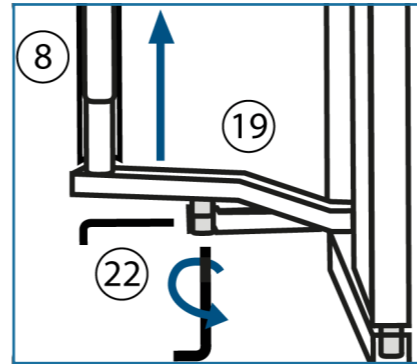

Innesto puntale
Cap insertion
Raccord du mandrin

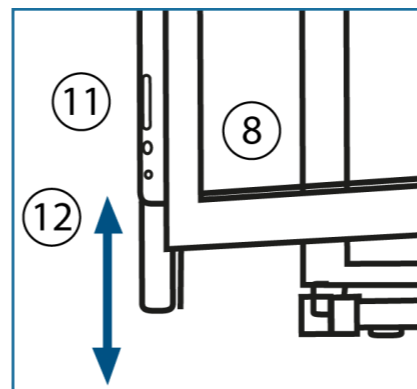



CANCELLO DI SICUREZZA SBALZO

CANTILEVER SECURITY GATE GRILLE DE SÉCURITÉ PORTE-À-FAUX

Scheda tecnica / Technical sheet / Fiche technique

 La vera evoluzione rispetto ai metodi tradizionali è l'apertura a sbalzo che rende i cancelli particolarmente avanzati dal punto di vista delle funzionalità e per la capacità di adattamento ad ogni problematica. Accedere alle persiane è comodo come utilizzare il meccanismo "Dual", poiché permette l'apertura a 180° delle ante sia verso l'interno che verso l'esterno, il tutto con la possibilità di realizzare al loro interno il disegno che si preferisce senza spaccature all'anta, potendo le stesse scavalcare le persiane per intero. La gamma di disegni che vi rendiamo disponibile è veramente vasta! Il motivo è che vi diamo la possibilità di realizzare disegni anche su vostra indicazione, per soddisfare il vostro gusto o per riprodurre lo stesso disegno utilizzato nel vostro condominio. Nonostante tutto, i disegni per cancelli più utilizzati si riducono a qualche decina, negli esempi presenti in questo catalogo ve ne mostriamo molti per fornirvi un'idea delle differenti tipologie.

 The real evolution in regards to traditional methods used in this field is our cantilever opening mechanism, which grants gates particularly advanced performance and makes them adaptable to any kind of application problem. Accessing shutters is as easy as with a Dual opening mechanism, since this kind of security grille allows for 180 degree opening of shutters both inward and outward; furthermore, any kind of design can be applied to the grilles without breaks, since they can slide over the shutters entirely. We have a very wide range of designs available, and we can even use your own design, to satisfy your personal taste or align the shutters to those already installed in your building. As always in PRO ART's philosophy, security must never compromise aesthetics, and aesthetics mustn't be a reason to renounce security - the very principle behind the highly customized production of our grilles and security gates. Even with such variety, the most often required designs number in a few dozens: in the pictures you can see several, so as to have a clear understanding of the different kinds.

 La vraie évolution par rapport aux méthodes traditionnelles est l'ouverture porte-à-faux, qui rend les grilles particulièrement avancées du point de vue de la fonctionnalité et de la capacité de s'adapter à tout problème. L'accès au volet est confortable comme avec le mécanisme « Dual », car ce mécanisme permet une ouverture à 180° des battants, vers l'intérieur et vers l'extérieur, tout en permettant de réaliser au dedans le dessin qu'on préfère sans couper le battant, vu que les grilles peuvent dépasser entièrement les volets. La gamme de dessins que nous mettons à votre disposition est vraiment ample ! La raison en est que nous vous donnons la possibilité de réaliser des dessins aussi selon votre indication, pour satisfaire votre goût ou pour reproduire le même dessin utilisé dans votre immeuble. En dépit de cette ample possibilité, les dessins pour les grilles les plus utilisés se réduisent à quelque dizaine. Dans les exemples, nous vous montrons plusieurs d'eux, pour vous donner une idée des différentes typologies.

Sbalzo normale
Normal cantilever
Porte-à-faux normale

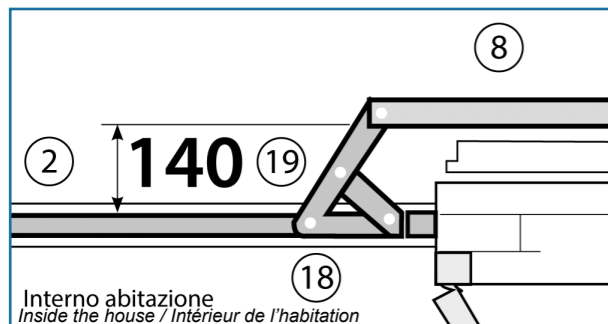

Sbalzo prolungato
Extended cantilever
Porte-à-faux prolongé

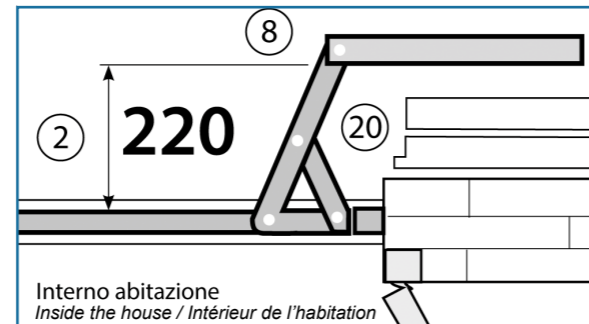

CANCELLO DI SICUREZZA ARCO

ARCH-SHAPED SECURITY GATE
GRILLE DE SÉCURITÉ ARCO

Scheda tecnica / Technical sheet / Fiche technique



Si possono realizzare lavorazioni ad arco ridotto o ad arco intero, a scelta da una sino a quattro ante, anche con parti laterali fisse.



Partial or Full arch shapes can be implemented, from one to four shutters, also with fixed side parts.



Il est possible de réaliser des usinages en arc réduit ou plein, avec entre une et quatre battants au choix, même avec des parties latérales fixes.

CANCELLO DI SICUREZZA SPANCIATI

CURVED SECURITY GATE
GRILLE DE SÉCURITÉ VOUTÉ

Scheda tecnica / Technical sheet / Fiche technique



La spanciatura del disegno delle grate fisse da un tocco di pregio alle finestre panoramiche, è possibile realizzare gli spanciati in 3 modi differenti come indicato nelle versioni A/B/C della scheda tecnica, la profondità e l'altezza della spanciatura si potrà avere delle dimensioni preferite segnalando gli assi x/y.



The curvature of fixed grilles design confers distinction to picture windows; curved grilles may be manufactured in 3 different versions, indicated as A/B/C in the technical sheet. Height and depth of the curvature may be obtained in the desired measurements by indicating them on X and Y axes.



La voute du dessin des grilles fixes donne une nuance de prestige aux fenêtres panoramiques. Il est possible de réaliser les voutes de 3 façons différentes, comme il est indiqué dans les versions A / B / C de la fiche technique. On pourra obtenir la profondeur et la hauteur de la voute en indiquant les dimensions désirées sur les axes x / y.

Vista frontale arco

Arch - frontal view / Vue de face de l'arc

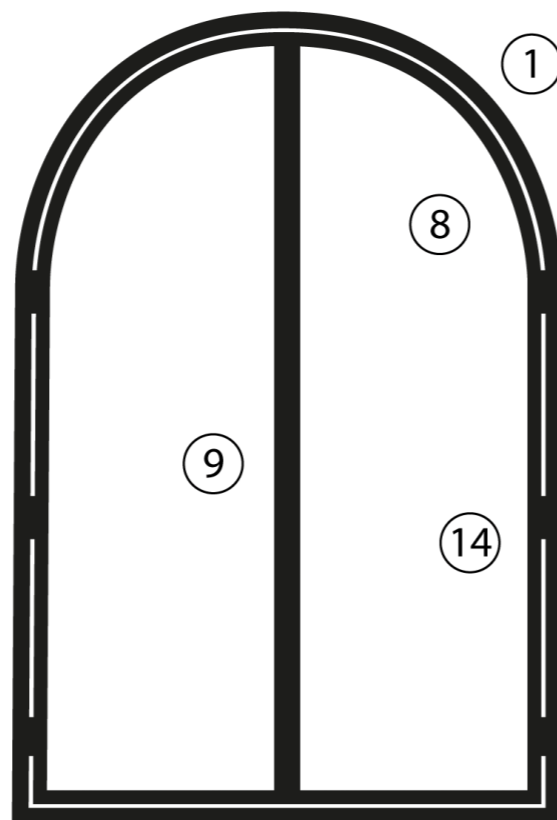

Prospettiva apertura esterna ad arco libero

Free arch outward opening perspective
Perspective d'ouverture vers l'extérieur en arc libre

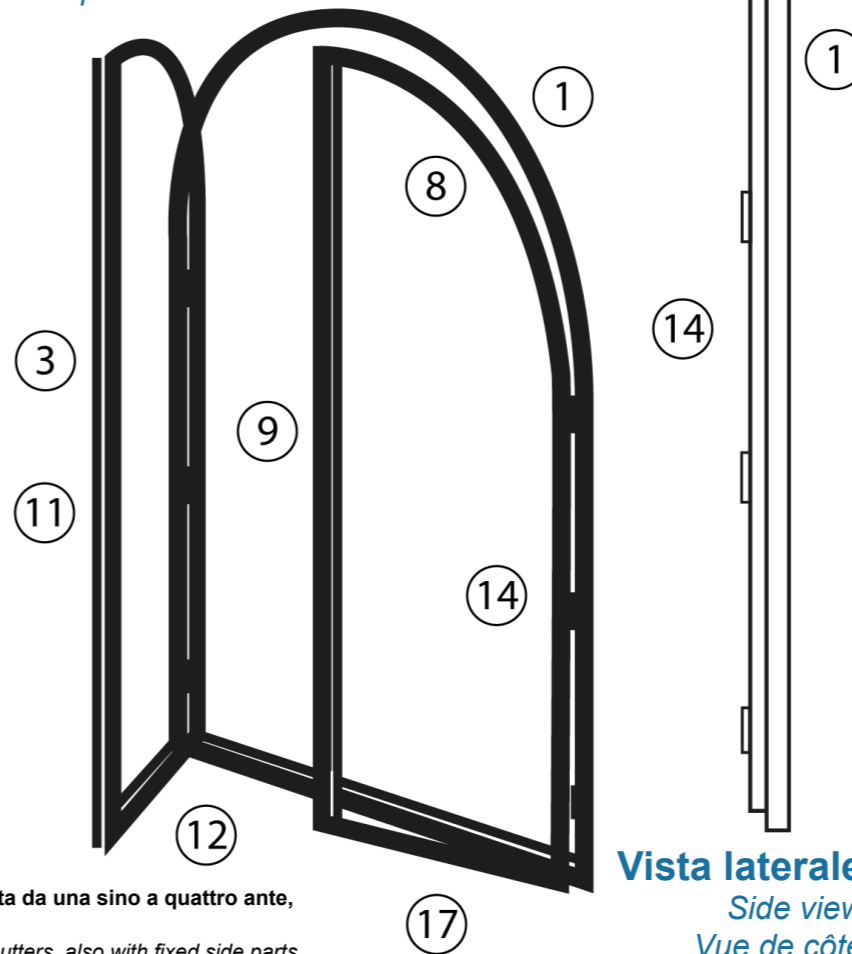

Vista laterale
Side view
Vue de côté

Realizzabile sia come arco ridotto che come arco intero, a scelta da una sino a quattro ante, anche con parti laterali fisse.
Partial or Full arch shapes can be implemented, from one to four shutters, also with fixed side parts.
À réaliser comme arc réduit ou plein, avec entre une et quatre battants au choix, même avec des parties latérales fixes.

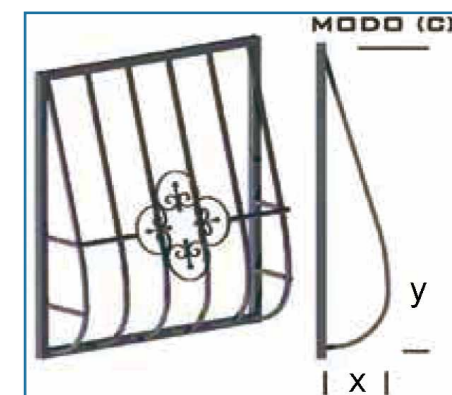
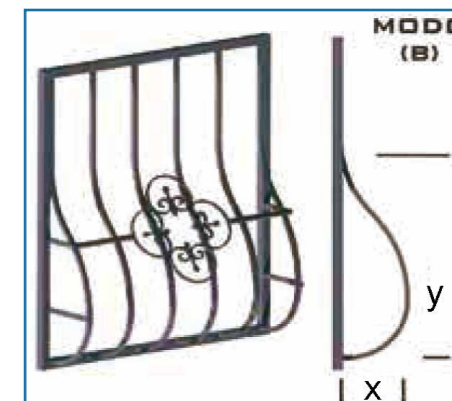
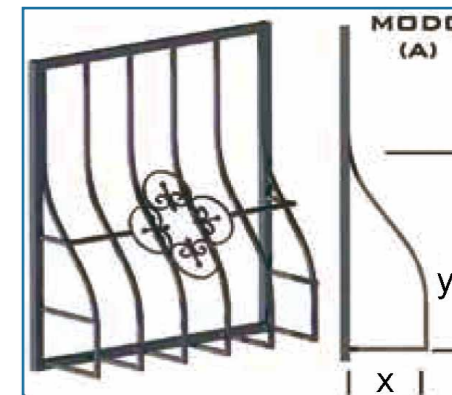

LEGENDA

- 1 - Telaio sagomato aperto spessore 25/10 misure standard 90 e 60mm.
- 2 - Semichiuso a "C" spessore 25/10 misure 30x30mm.
- 3 - Serratura a montante con 3 punti di chiusure azionata con cilindro europeo a spine unificato.
- 7 - Tasselli in nylon con vite in acciaio a testa svasata e chiave ad inserto torx adibiti al fissaggio del telaio, dotati di tappo in plastica nera di finitura.
- 8 - Tubolare con incavo e finiture arrotondata sul lato del disegno avente spessore 15/10.
- 9 - Battuta di protezione esterna spessore 50/10.
- 10 - Espansori applicati sul telaio per tensionare il pezzo in fase di installazione e compensare le irregolarità del muro.
- 11 - Aste di chiusura diametro 20mm con supporto puntale.
- 12 - Puntale in acciaio pieno, adibito ad inserimento su asola di innesto sul telaio.
- 14 - Cerniera a tappo misura 130mm dotate di cuscinetto a sfere.
- 17 - Asola su telaio per inserimento puntale.
- 18 - Montante del telaio rotante in tubo 30x30mm spessore 40/10.
- 19 - Piatti in 30x15mm costituenti il meccanismo a sbalzo normale.
- 20 - Piatti in 30x15mm costituenti il meccanismo a sbalzo prolungato.
- 21 - Sistema di regolazione orizzontale per ante su meccanismo a sbalzo e grano di blocco.
- 22 - Sistema di regolazione verticale per ante su meccanismo a sbalzo.



KEY

- 1 - Open moulded frame, thickness 25/10, standard measurements 90 and 60 mm.
- 2 - Half-closed, C shape, thickness 25/10, measurements 30x30mm.
- 3 - Lock pillar with 3 closing points, activated through European unified pin tumbler cylinder.
- 7 - Nylon dowels with countersunk headed steel screw and torx wrench insert for frame fixing, with security star and finishing black plastic cover.
- 8 - Finished and socketed tubular structure, curved on the design side - Thickness 15-10
- 9 - External protection jamb - thickness 50/10
- 10 - Expanders applied to the frame, to straighten the piece during installation and compensate for wall unevenness
- 11 - Closing rods, 20 mm diameter, with cap support
- 12 - Solid steel cap, for insertion in on-frame loop
- 14 - Plug hinge with ball bearing, size 130 mm
- 17 - On-frame loop for cap insertion
- 18 - Revolving frame pillar, 30x30 mm pipe, thickness 40/10
- 19 - 30x15 mm components for standard cantilever mechanism
- 20 - 30x15mm components for extended cantilever mechanism
- 21 - Horizontal shutter calibration system for cantilever mechanisms, with locking dowel
- 22 - Vertical shutter calibration system for cantilever mechanisms



LÉGENDE

- 1 - Châssis ouvert en forme, épaisseur 25/10, dimension standard 90 et 60mm.
- 2 - Semi-fermée en « C », épaisseur 25/10, dimension 30x30mm.
- 3 - Serrure à montant avec 3 points de fermeture, actionnée avec un cylindre profil européen à goupilles unifié.
- 7 - Les goujons en nylon avec vis en acier à tête fraisée et clé torx pour fixer le châssis, équipés avec un capuchon de finition en plastique noir.
- 8 - Tubulaire avec cavité et finitions arrondies sur le côté du dessin avec une épaisseur de 15/10.
- 9 - Butée de protection externe, épaisseur 50/10
- 10 - Extensions appliqués sur le châssis pour tendre la pièce lors de l'installation et compenser les irrégularités du mur.
- 11 - Barre de fermeture de 20 mm de diamètre avec support du mandrin
- 12 - Mandrin en acier pleine, utilisée pour l'insertion dans l'œillet sur le châssis
- 14 - Charnière capuchon 130mm équipée d'un palier à billes
- 17 - Œillet sur le châssis pour l'insertion du mandrin
- 18 - Montant du châssis tournant en tube 30x30mm d'épaisseur 40/10
- 19 - Plateaux 30x15mm constituant le mécanisme porte-à-faux normal.
- 20 - Plateaux 30x15mm constituant le mécanisme porte-à-faux étendu
- 21 - Système de réglage horizontal pour battants sur mécanisme porte-à-faux et grain de blocage
- 22 - Système de réglage vertical pour battants sur mécanisme porte-à-faux

LINEA SPECIAL / "SPECIAL" LINE / LIGNE SPECIAL

Alba (α β)

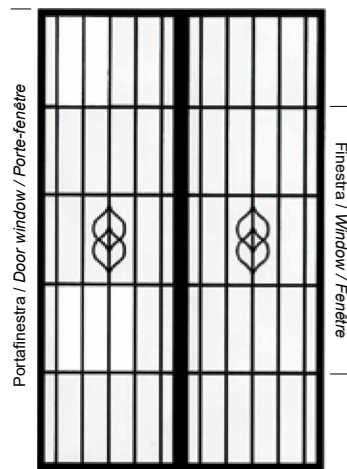

Ambra (α β)

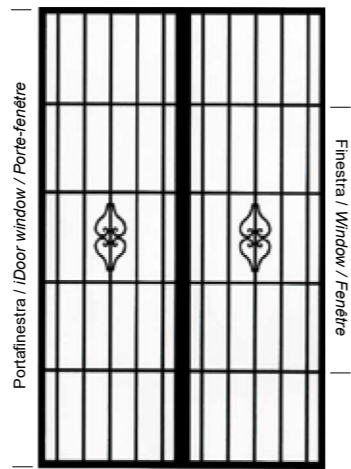

Matilde (α β)



Arrigo (α β)

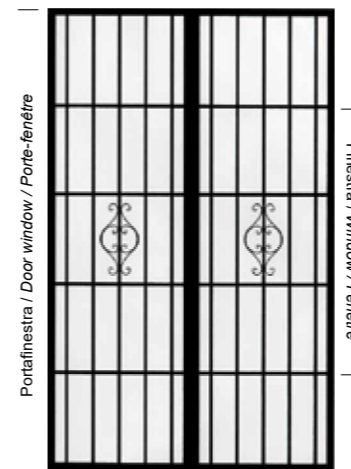

India (α β)

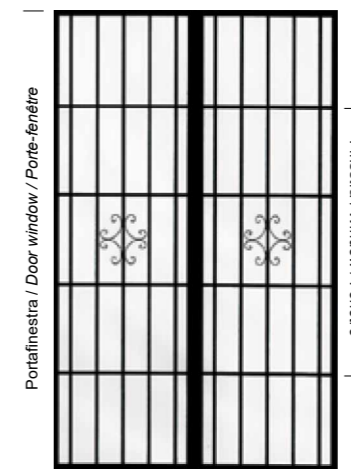

Vecchia Milano (α β)

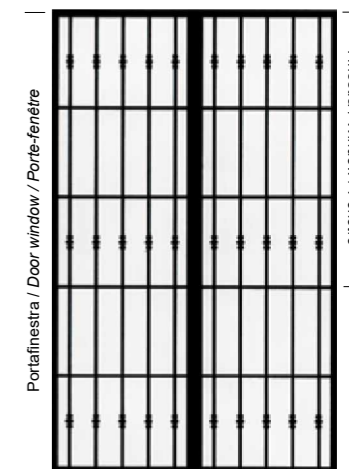

DISEGNI DI SERIE / STANDARD DESIGNS / DESSINS STANDARD

Brand (α β)

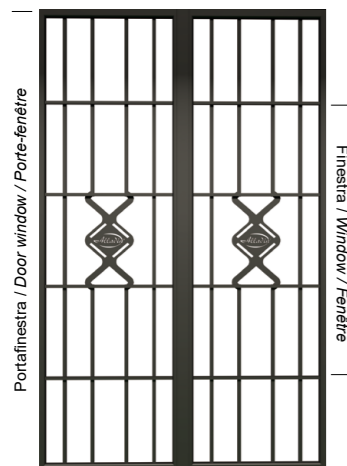

Semplice (α β)

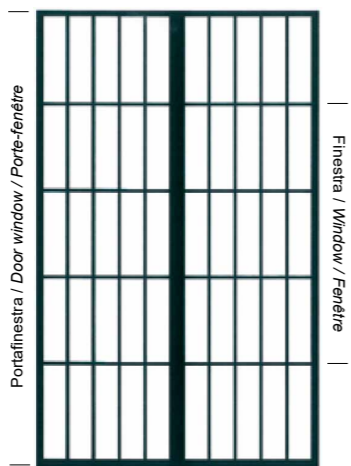

Stilo (α β)

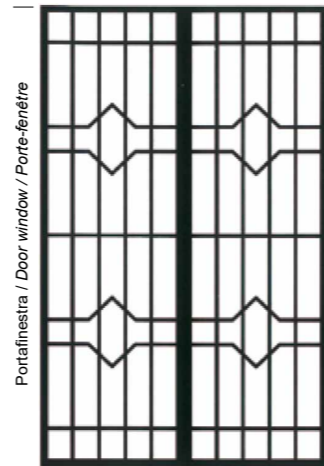

Visconteo (α β)

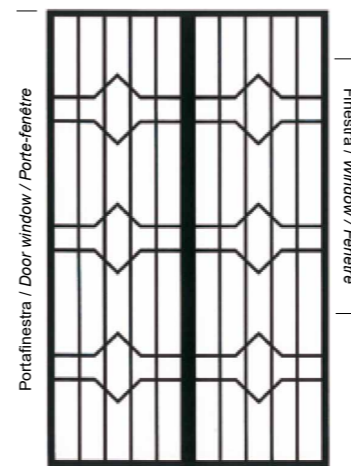

Cerchi (β δ σ)

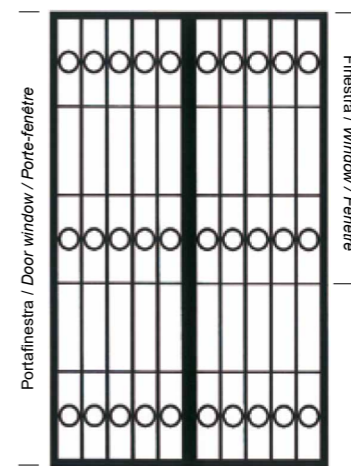

Pantografo (β σ)

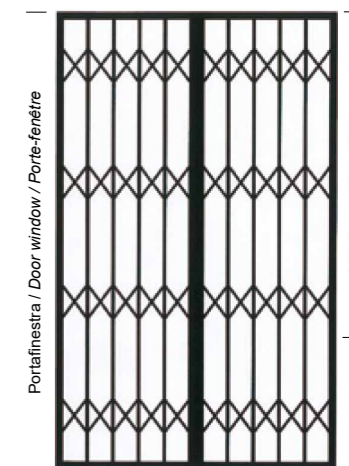

Vecchia Milano (γ δ σ)
con pannello PR1 / with panel PR1 /
avec panneau PR1

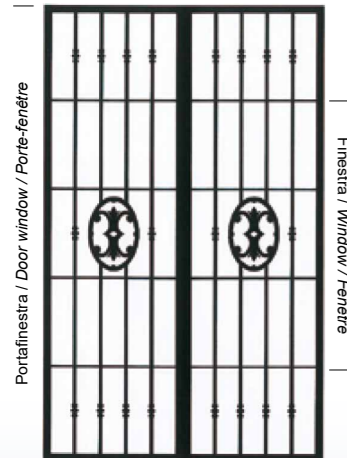

Inglese (γ δ σ)
con pannello PR2 / with panel PR2 /
avec panneau PR2

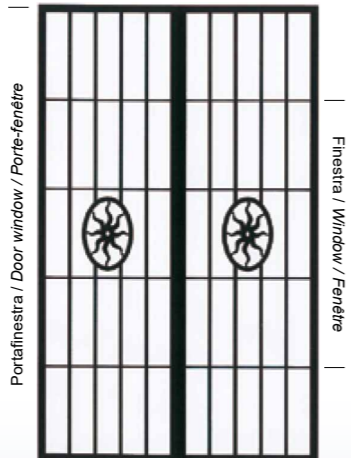

Inglese (γ δ σ)



Sforza (α β ε ψ)

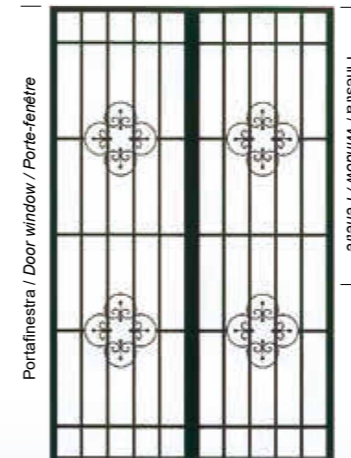

Rubino (α β)

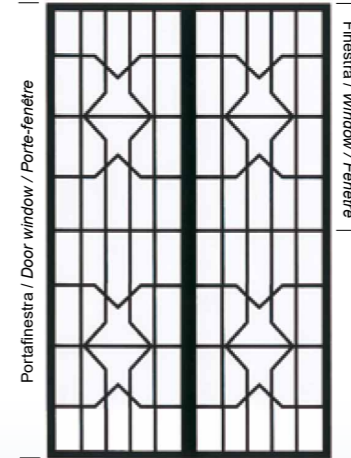

Demetrio (α β)

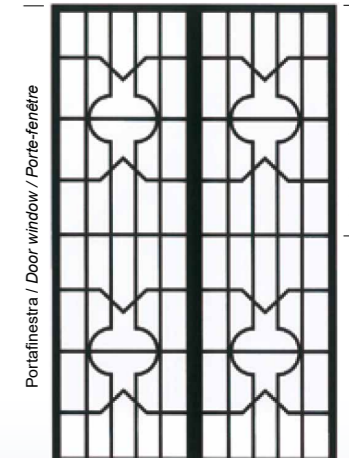

DISEGNI DI SERIE / STANDARD DESIGNS / DESSINS STANDARD

Oscar (α β)

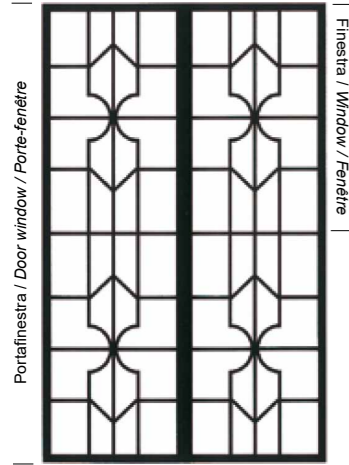

Cristina (γ δ σ)

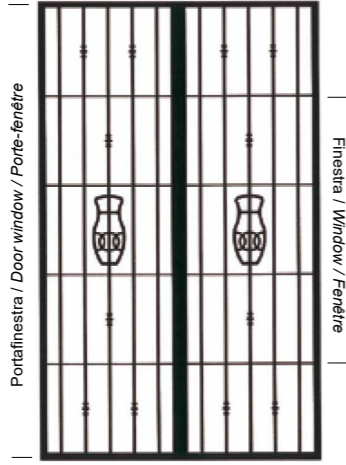

Ada (γ δ σ)

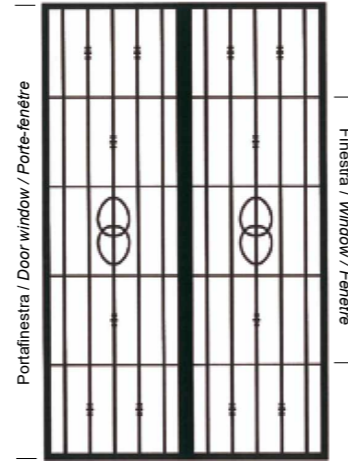

Alba (γ δ σ)

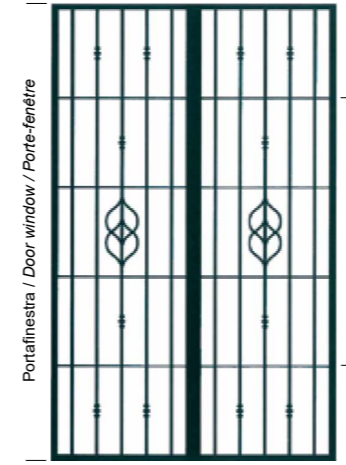

Matilde (γ δ σ)

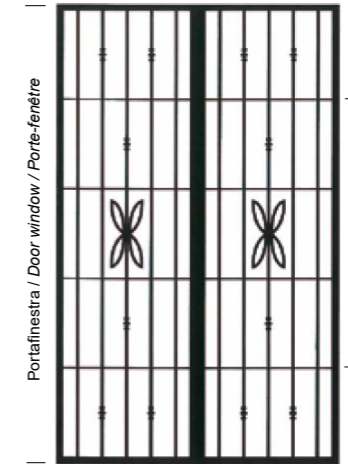

Infinito (α β)

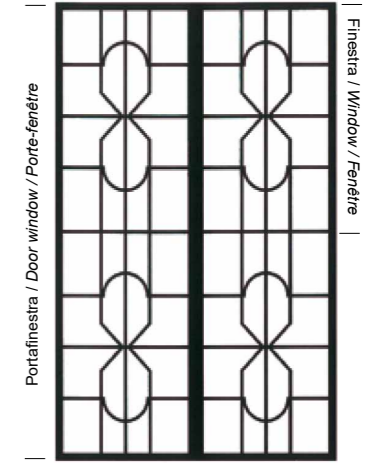

Vecchia Milano (γ δ σ)

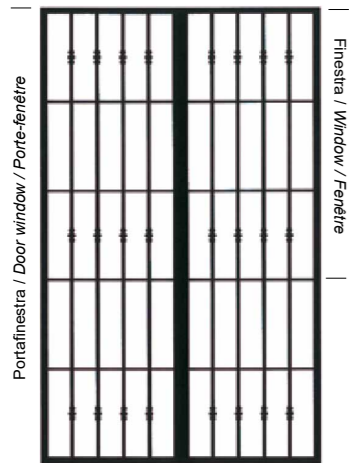

Alida (α β)

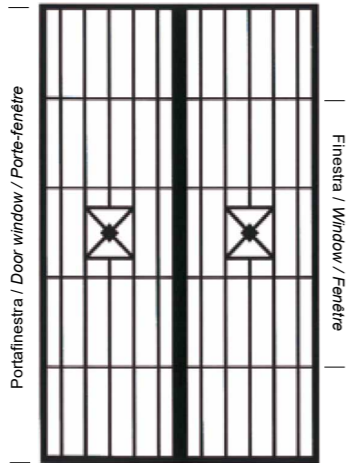

Fiore (β δ ε σ)

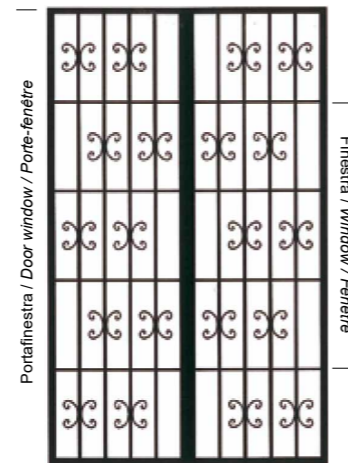

Barbara (γ δ σ)

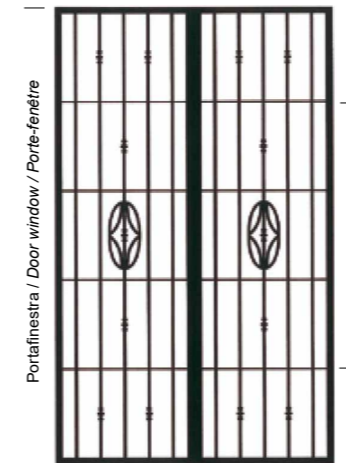

Ambra (γ δ σ)

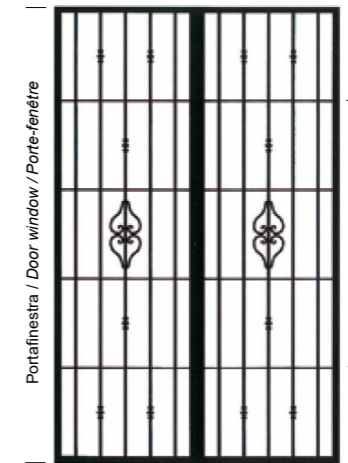

India (γ δ ε σ)

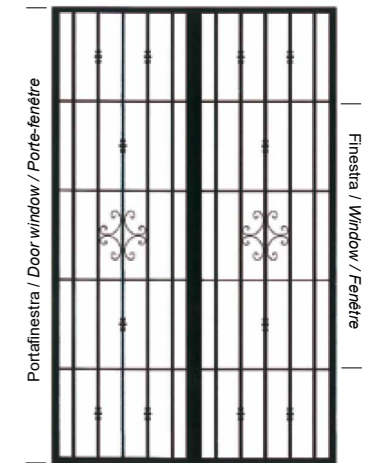

Arrigo (γ δ σ)

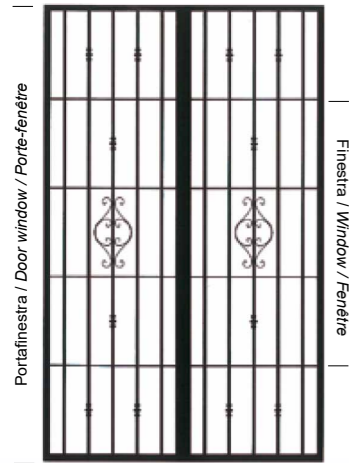

Cuori (γ δ σ)

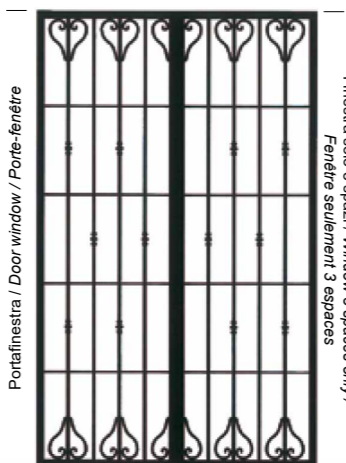

Noce (β ε σ)

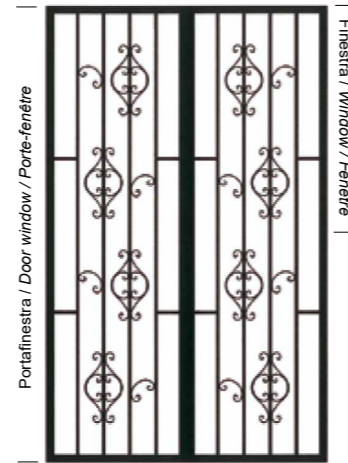

Tulipano (γ δ σ)

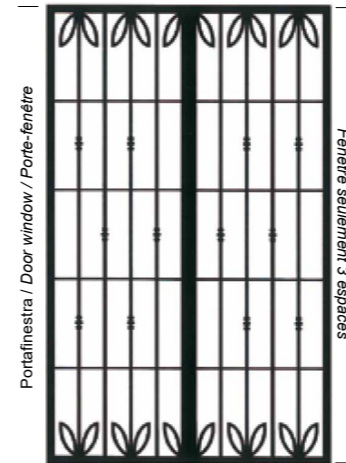

Doppiopantografo (β δ σ)

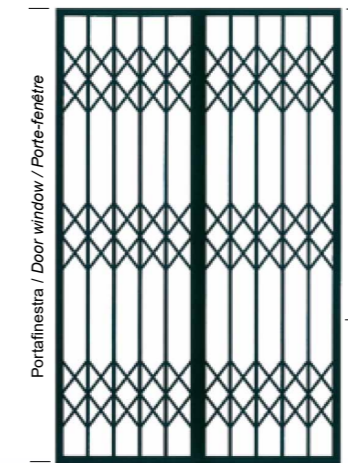

Milanesio (γ σ)

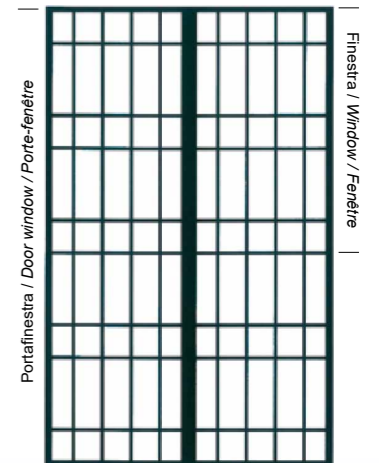

DISEGNI DI SERIE / STANDARD DESIGNS / DESSINS STANDARD

Milano Antica (γ δ σ)

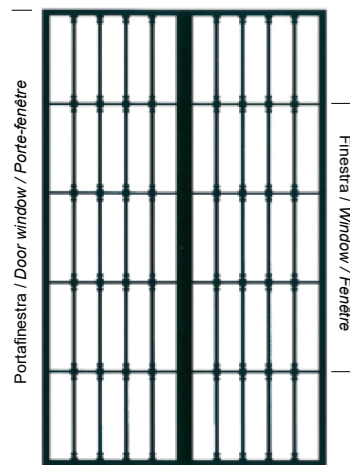

Pittoresco (γ δ σ)

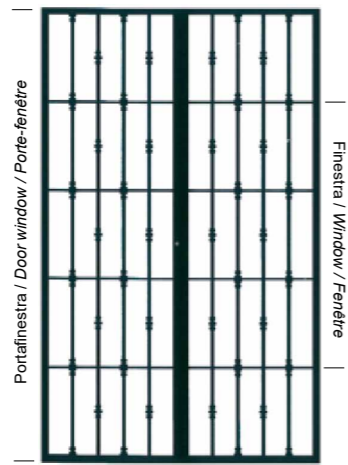

Alternato (β σ)

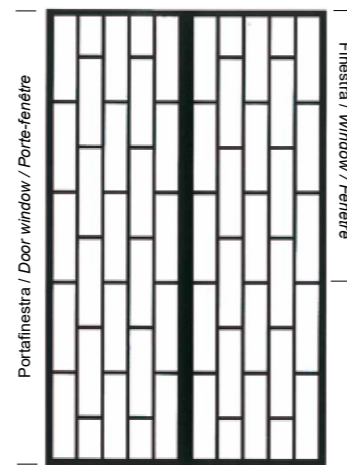

Rombi (α β)

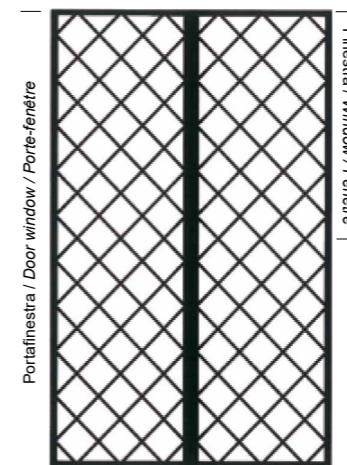

Gaj (β δ σ)

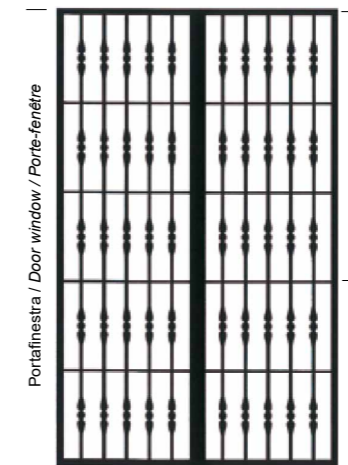

Impero (γ δ ε σ)



LINEA LUXURY / "LUXURY" LINE / LIGNE LUXURY

Storico (γ σ)

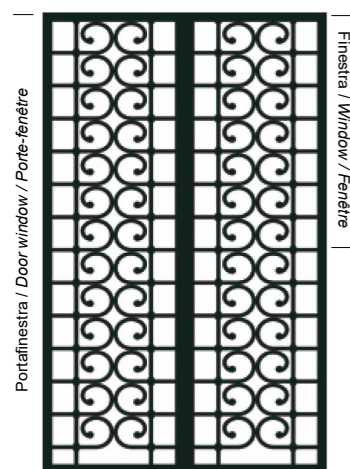

Ferri (γ σ)

con pannello PR1 / with panel PR1 /
avec panneau PR1

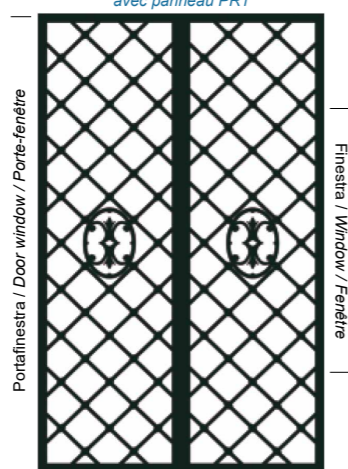

Salisburghese (σ δ)

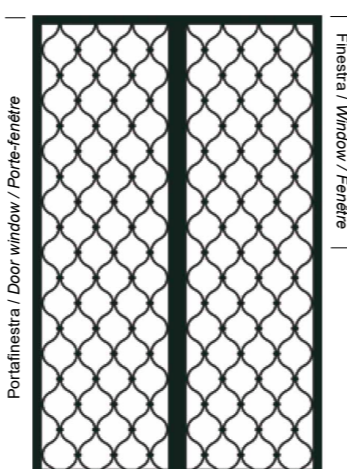

Mosaico (σ δ)

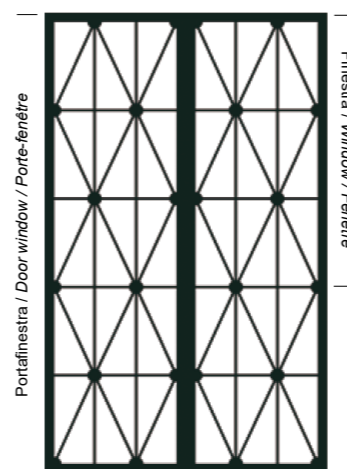

LEGENDA

- α - Disegni sovrapposti
- β - Disegni con quadro 14x14 pieno
- γ - Disegni con tondo diametro 16 pieno
- δ - Disegni con piatto spessore 5
- ε - Disegni con riccioli spessore 4
- σ - Disegni coplanari
- λ - Disegni con riccioli spessore 8
- ψ - Disegni con riccioli fascettati



KEY

- α - Overlapping designs
- β - Designs with full 14x14 square
- γ - Designs with full 16 - diameter circle
- δ - Designs with flat, thickness 5
- ε - Designs with curls, thickness 4
- σ - Coplanar designs
- λ - Designs with curls, thickness 8
- ψ - Designs with wrapped curls



LÉGENDE

- α - Dessins superposés
- β - Dessins avec un carré 14x14 plein
- γ - Dessins avec un cercle de diamètre 16
- δ - Dessins avec une plaque d'épaisseur 5
- ε - Dessins avec des boucles d'épaisseur 4
- σ - Dessins coplanaires
- λ - Dessins avec des boucles d'épaisseur 8
- ψ - Dessins avec des boucles groupées

PANNELLI DECORATIVI / DECORATIVE PANELS / PANNEAUX DÉCORATIFS

I pannelli decorativi possono intersecare uno oppure due montanti in base alle dimensioni del cancello.
Decorative panels may intersect one or two pillars, depending on gate size.
Les panneaux décoratifs peuvent croiser un ou deux montants selon la dimension de la grille.

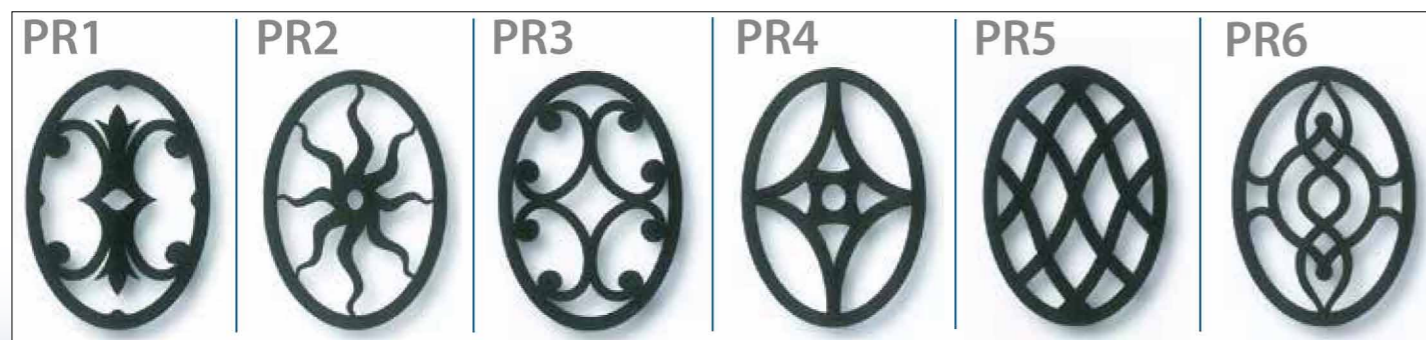

Disegni disponibili sia per chiusure fisse che per ogni sistema di apertura. I prezzi si intendono rigorosamente con nessuna modifica rispetto al disegno.
Disponibili in tutti i colori standard e in tutte le soluzioni Alladin®.
Designs are available both for fixed closures and for any opening system. Prices are strictly intended as having no modification to the design. Available in all standard colours and all Alladin® solutions.
Dessins disponibles pour les fermetures fixes et pour tout système d'ouverture. Les prix s'entendent strictement sans changement par rapport au dessin.
Disponible dans toutes les couleurs standard et dans toutes les solutions Alladin®.

COLORI RAGGRINZATI - RAL / TEXTURED COLOURS - RAL / COULEURS GRAPHIQUES - RAL



NERO / BLACK / NOIR Ral 9005
Tiefschwarz



AVORIO / IVORY / IVOIRE Ral 1013
Perlweiß



AVORIO / IVORY / IVOIRE Ral 1015
Hellelfenbein



AVORIO / IVORY / IVOIRE Ral 1011
Braunbeige



BIANCO / WHITE / BLANC Ral 9002
Grauweiß



BIANCO / WHITE / BLANC Ral 9010
Reinweiß



GRIGIO / GREY / GRIS Ral 7035
Lichtgrau



GRIGIO / GREY / GRIS Ral 7001
Silbergrau

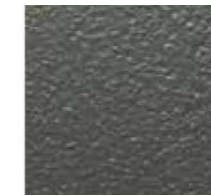

GRIGIO / GREY / GRIS Ral 7015
Schiefergrau

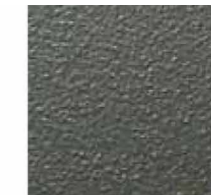

GRIGIO / GREY / GRIS Ral 7024
Graphitgrau



ROSSO / RED / ROUGE Ral 3009
Oxidrot



MARRONE / BROWN / MARRON Ral 8001
Ockerbraun



MARRONE / BROWN / MARRON Ral 8003
Lehmbraun



MARRONE / BROWN / MARRON Ral 8011
Nußbraun



MARRONE / BROWN / MARRON Ral 8016
Mahagonibraun



MARRONE / BROWN / MARRON Ral 8017
Schokoladenbraun



MARRONE / BROWN / MARRON Ral 8019
Graubraun



VERDE / GREEN / VERT Ral 6021
Blaßgrün



VERDE / GREEN / VERT Ral 6011
Rasedagrün



VERDE / GREEN / VERT Ral 6005
Moosgrün



VERDE / GREEN / VERT Ral 6009
Tannengrün

COLORI PARTICOLARI / SPECIAL COLOURS / COULEURS PARTICULIÈRES



Nero brillantinato
Glittery black
Noir brillant



MAREZZATI - Bianco marezzato
MARbled - Marbled white
MARBRÉ - Blanc marbré



MAREZZATI - Grigio marezzato
MARbled - Marbled grey
MARBRÉ - Gris marbré



MAREZZATI - Verde marezzato
MARbled - Marbled green
MARBRÉ - Vert marbré



MAREZZATI - Marrone marezzato
MARbled - Marbled brown
MARBRÉ - Marron marbré



SABLE' - Nero sablé
SABLÈ - Sablè black
SABLÉ - Noir sablé



SABLE' - Grigio sablé
SABLÈ - Sablè grey
SABLÉ - Gris sablé



SABLE' - Verde scuro sablé
SABLÈ - Sablè dark green
SABLÉ - Vert foncé sablé



SABLE' - Marrone sablé
SABLÈ - Sablè brown
SABLÉ - Marron sablé



Corten
Corten
Corten

Le immagini, i colori, le misure, i dati e le caratteristiche tecniche possono subire variazioni senza preavviso.

Images, colours, measurements, data and technical specifications may be subject to modification without warning / Les images, couleurs, mesures, données et caractéristiques techniques peuvent être modifiées sans avis préalable

COLORI EFFETTO LEGNO / WOOD EFFECT COLOURS / COULEURS D'EFFET DE BOIS

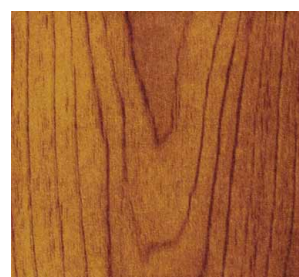

Acero
Maple / Érable



Bianco rovere
White durmast /
Blanc chêne rouvre

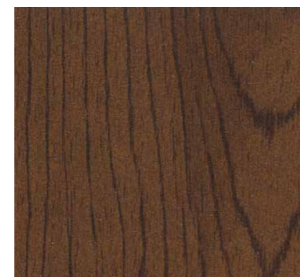

Castagno
Chestnut / Châtaigne



Ciliegio
Cherry / Cerisier



Ciliegio 317
317 Cherry / Cerisier 317



Ciliegio 317 chiaro
Light Cherry 317 /
Cerisier 317 clair



Ciliegio rosso
Red cherry / Rouge cerisier



Corten
Corten / Corten

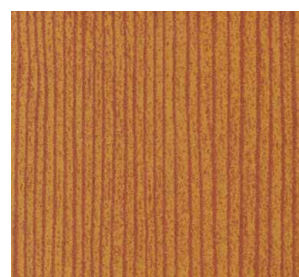

Douglas
Douglas / Douglas



Faggio
Beech / Hêtre



Frassino
Ash / Frêne



Noce
Walnut / Noyer

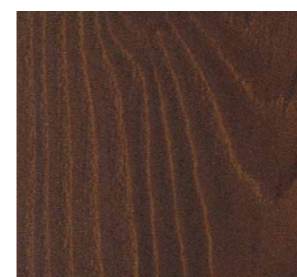

Noce 3D
3D Walnut / Noyer 3D



Noce anticato
Aged walnut / Noyer vieilli

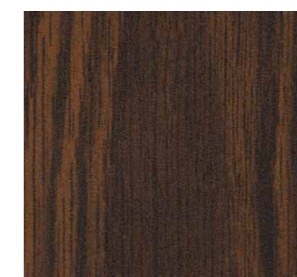

Olmo
Elm / Ormeau



Pino
Pine / Pin



Quercia invecchiata
Aged oak / Chêne vieilli



Quercia naturale
Natural oak / Chêne naturel



Renolit
Renolit / Renolit



Renolit scuro
Dark renolit / Renolit foncé



Rovere
Durmast / Chêne rouvre



Rovere grigia
Grey durmast /
Gris chêne rouvre



Teak
Teak / Teck



Verde rovere
Green durmast /
Vert chêne rouvre

Le immagini, i colori, le misure, i dati e le caratteristiche tecniche possono subire variazioni senza preavviso.

Images, colours, measurements, data and technical specifications may be subject to modification without warning / Les images, couleurs, mesures, données et caractéristiques techniques peuvent être modifiées sans avis préalable

Le nostre proposte
Our proposals / Nos propositions



Rivenditore autorizzato
Authorized dealer / Concessionnaire autorisé